



## TECHNICAL SPECIFICATION / TECHNISCHE BESCHREIBUNG / DESCRIPTION TECHNIQUE

### Glass top Glasplatte Top verre

OPTIWHITE Glass painted on the underside  
Glas OPTIWHITE von unten bemalt  
Verre OPTIWHITE laque d'en-dessous  
8mm

### Front / Front / Façade

Powder-coated metal  
element with plexiglass  
Metall pulverbeschichtet, Plexiglas  
Éléments en plexiglass dans l'habillage  
en acier peint en poudre

### Illumination Beleuchtung Illumination

RGBW LED

### Worktop Arbeitsplatte Plan de travail

MFC / Melaminplatte /  
Panneau mélaminé  
28mm

### Lower side panel Wangenfuß niedrig Pied bas

MFC / Melaminplatte /  
Panneau mélaminé  
28mm

### Level adjusters Bodenausgleich Vérins de réglage

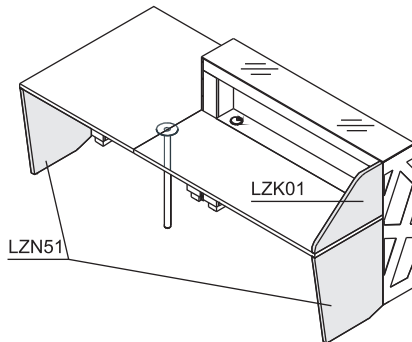
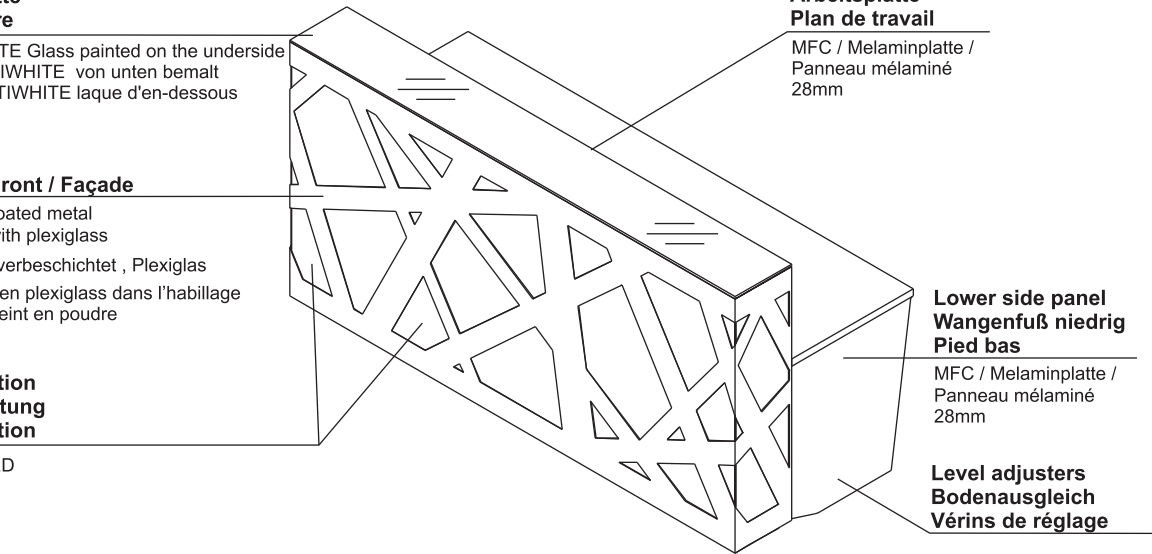

### Cable-way Kabeldurchlass Obturateur

∅ 80mm

### Supporting leg where worktops connect Stützfuß Nécessaire sur la jonction des banquettes

NE41 required on all connections of receptions /  
NE41 Stützfuß zusätzlich zur Verbindung der  
Thekenelemente bestellen /  
NE41 nécessaire sur la connexion des banquettes  
15 - METAL, HIGH GLOSS WHITE  
15 - METALL, WEIß GLANZ  
15 - METAL, BLANC BRILLANT

### Upper side panel Endungselement Panneau latéral

MFC / Melaminplatte /  
Panneau mélaminé  
28mm

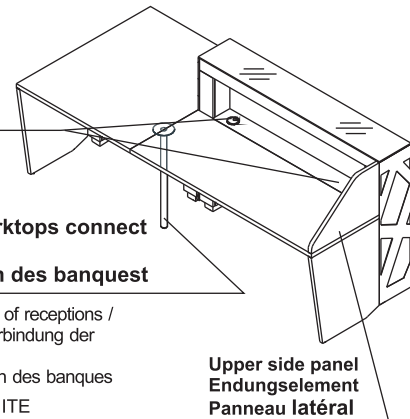

## DIMENSIONS / ABMESSUNGEN / DIMENSIONS

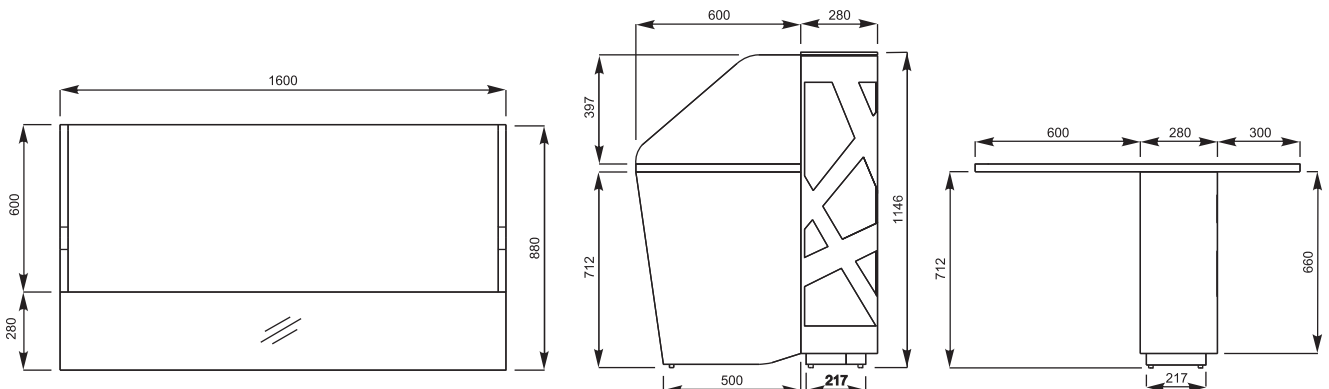

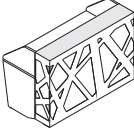
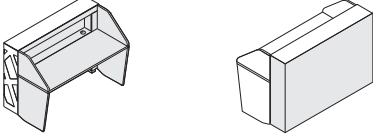
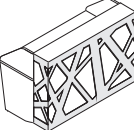
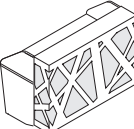

## FINISHES / FARBEN / FINITIONS

<p>TEMPERED GLASS, WHITE HARTGLAS, WEIß VERRE TREMPÉ, BLANC</p>	
<p>67 WHITE PASTEL WEIß PASTELL BLANC PASTEL</p>	
<p>15 WHITE METAL WEIß METAL BLANC</p>	
<p>PLEXIGLASS WHITE PLEXIGLAS WEIß PLEXIGLASS BLANC</p>	



RECEPTION DESK SYSTEMS / EMPFANGSTHEKEN-SYSTEME / CONFIGURATIONS DES BANQUES

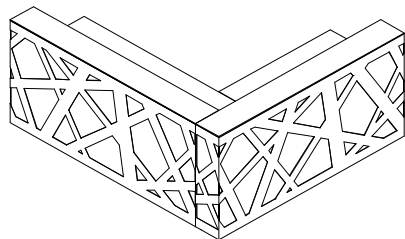

LZN51+LZG22+LZB22+NE41+LZG22+LZB22M

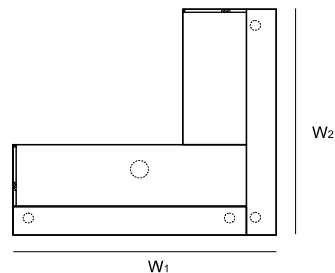

INDEX SYMBOL	DIMENSIONS / ABMESSUNGEN [mm]										COMMENTS / BEMERKUNGEN / REMARQUES
	W <sub>1</sub>	W <sub>2</sub>	D <sub>1</sub>	D <sub>2</sub>	H						
<b>LZG44</b>	2480	2200	-	-	1146		293.7	3.186	18		

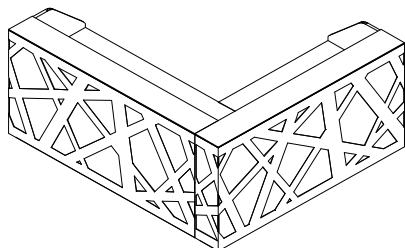

LZK01+LZN51+LZG22+LZB22+NE41+LZG22+LZB22M

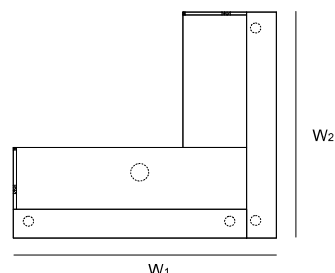

INDEX SYMBOL	DIMENSIONS / ABMESSUNGEN [mm]										COMMENTS / BEMERKUNGEN / REMARQUES
	W <sub>1</sub>	W <sub>2</sub>	D <sub>1</sub>	D <sub>2</sub>	H						
<b>LZG45</b>	2480	2200	-	-	1146		300.7	3.206	19		

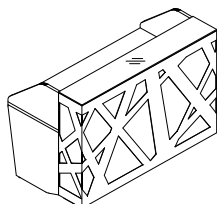

LZ034 - LZK01+LZN51+LZG16+LZB16  
LZ046 - LZK01+LZN51+LZG22+LZB22+NE41

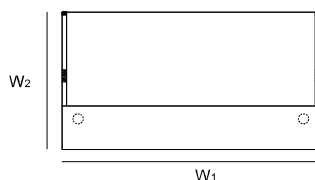

INDEX SYMBOL	DIMENSIONS / ABMESSUNGEN [mm]										COMMENTS / BEMERKUNGEN / REMARQUES
	W <sub>1</sub>	W <sub>2</sub>	D <sub>1</sub>	D <sub>2</sub>	H						
<b>LZG34</b>	1600	880	-	-	1146		131.9	1.250	9		
<b>LZG46</b>	2200	880	-	-	1146		165.4	1.648	10		

DESCRIPTION / LEGENDE / LÉGENDE:

net weight / Nettogewicht / poids net

volume / Volumen / le volume

number of packages / Stückzahl der Pakete / nombre de colis



RECEPTION DESK SYSTEMS / EMPFANGSTHEKEN-SYSTEME / CONFIGURATIONS DES BANQUES

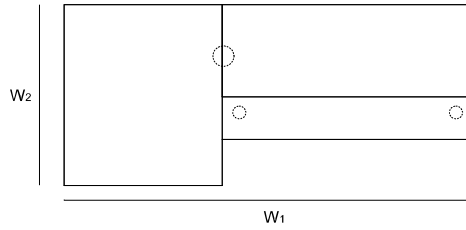
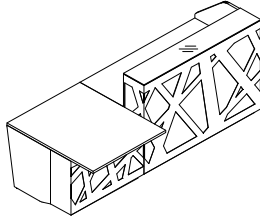

1xNE41 16 16  
LZN51+LZG10+2xNE41+LZG22+LZB22+LZK01

INDEX SYMBOL	DIMENSIONS / ABMESSUNGEN [mm]						⚖️	📦	📦	COMMENTS / BEMERKUNGEN / REMARQUES
	W <sub>1</sub>	W <sub>2</sub>	D <sub>1</sub>	D <sub>2</sub>	H		kg	m <sup>3</sup>	pcs	
<b>LZG50</b>	2600	1180	-	-	1146		218.4	1.822	15	
<b>LZG51</b>	3200	1180	-	-	1146		250.4	2.203	15	

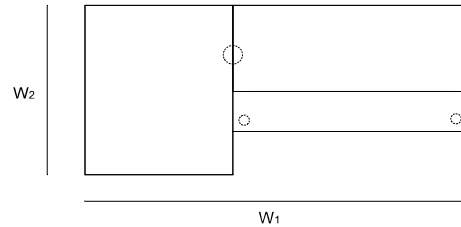
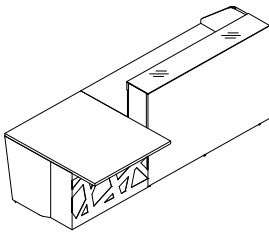

LZB16+LZG16M+LZG10+LZN51+LZK01+NE41

INDEX SYMBOL	DIMENSIONS / ABMESSUNGEN [mm]						⚖️	📦	📦	COMMENTS / BEMERKUNGEN / REMARQUES
	W <sub>1</sub>	W <sub>2</sub>	D <sub>1</sub>	D <sub>2</sub>	H		kg	m <sup>3</sup>	pcs	
<b>LZG56</b>	2600	1180	-	-	1146		220.4	1.822	15	

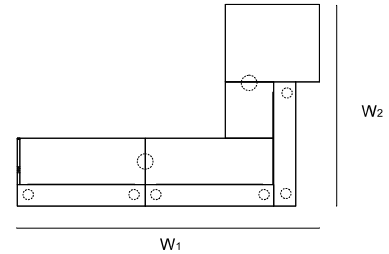
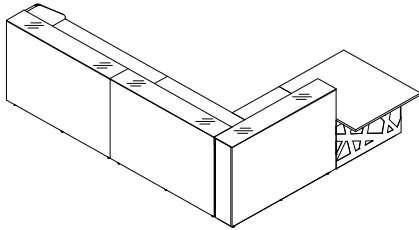

3xLZG16M+LZG10+LZK01+LZN51+LZB16M+2xLZB16+3xNE41

INDEX SYMBOL	DIMENSIONS / ABMESSUNGEN [mm]						⚖️	📦	📦	COMMENTS / BEMERKUNGEN / REMARQUES
	W <sub>1</sub>	W <sub>2</sub>	D <sub>1</sub>	D <sub>2</sub>	H		kg	m <sup>3</sup>	pcs	
<b>LZG57</b>	3200	2880	-	-	1146		439.2	4.215	31	

DESCRIPTION / LEGENDE / LÉGENDE:

⚖️ net weight / Nettogewicht / poids net

📦 volume / Volumen / le volume

📦 number of packages / Stückzahl der Pakete / nombre de colis



RECEPTION DESK SYSTEMS / EMPFANGSTHEKEN-SYSTEME / CONFIGURATIONS DES BANQUES

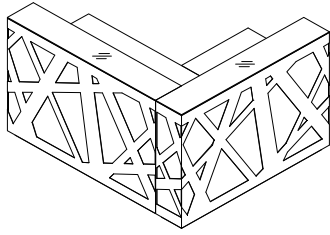

LZN51+LZG16W+LZB16+LZG16+LZB16M

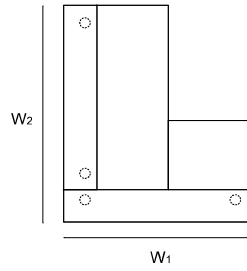

INDEX SYMBOL	DIMENSIONS / ABMESSUNGEN [mm]						⚖️	📦	📦		COMMENTS / BEMERKUNGEN / REMARQUES
	W <sub>1</sub>	W <sub>2</sub>	D <sub>1</sub>	D <sub>2</sub>	H						
<b>LZG32</b>	1600	1880	-	-	1146		227.5	2.395	16		

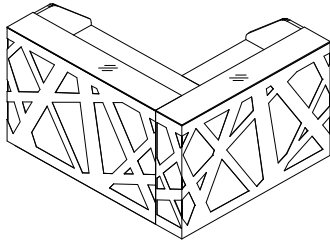

LZK01+LZN51+LZG16+LZB16+LZG16+LZB16M

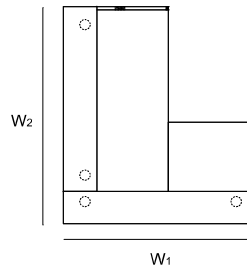

INDEX SYMBOL	DIMENSIONS / ABMESSUNGEN [mm]						⚖️	📦	📦		COMMENTS / BEMERKUNGEN / REMARQUES
	W <sub>1</sub>	W <sub>2</sub>	D <sub>1</sub>	D <sub>2</sub>	H						
<b>LZG35</b>	1600	1880	-	-	1146		234.5	2.414	17		

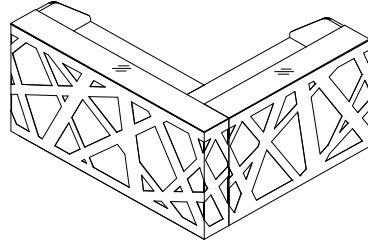

LZK01+LZN51+LZG22+LZB22M+LZG16+LZB16

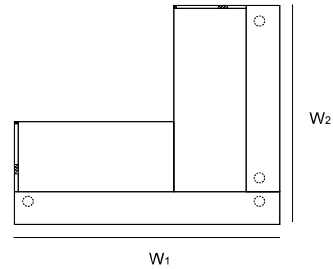

INDEX SYMBOL	DIMENSIONS / ABMESSUNGEN [mm]						⚖️	📦	📦		COMMENTS / BEMERKUNGEN / REMARQUES
	W <sub>1</sub>	W <sub>2</sub>	D <sub>1</sub>	D <sub>2</sub>	H						
<b>LZG36</b>	2200	1880	-	-	1146		266.5	2.807	17		

DESCRIPTION / LEGENDE / LÉGENDE:

⚖️ net weight / Nettogewicht / poids net

📦 volume / Volumen / le volume

📦 number of packages / Stückzahl der Pakete / nombre de colis



RECEPTION DESK SYSTEMS / EMPFANGSTHEKEN-SYSTEME / CONFIGURATIONS DES BANQUES

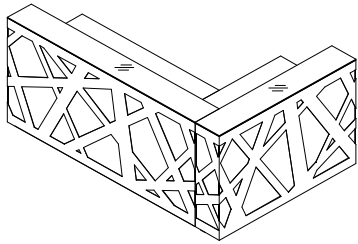

LZN51+LZG22+LZB16+LZG16+LZB22M

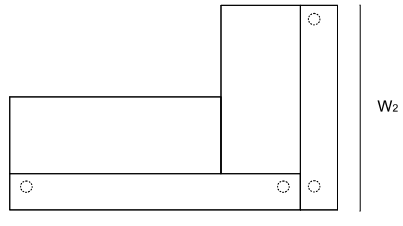

W1

INDEX SYMBOL	DIMENSIONS / ABMESSUNGEN [mm]									COMMENTS / BEMERKUNGEN / REMARQUES
	W <sub>1</sub>	W <sub>2</sub>	D <sub>1</sub>	D <sub>2</sub>	H		kg	m <sup>3</sup>	pcs	
<b>LZG38</b>	2480	1600	-	-	1146		259.5	2.788	16	

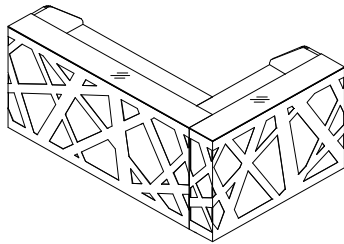

LZK01+LZN51+LZG22+LZB16+LZG16+LZB22M

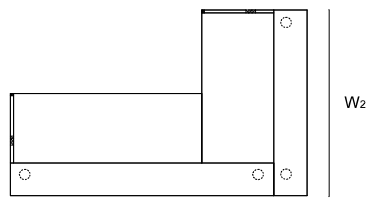

W1

INDEX SYMBOL	DIMENSIONS / ABMESSUNGEN [mm]									COMMENTS / BEMERKUNGEN / REMARQUES
	W <sub>1</sub>	W <sub>2</sub>	D <sub>1</sub>	D <sub>2</sub>	H		kg	m <sup>3</sup>	pcs	
<b>LZG40</b>	2480	1600	-	-	1146		266.5	2.807	17	

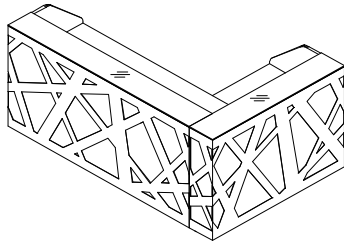

LZK01+LZN51+LZG22+LZB22+NE41+LZG16+LZB16M

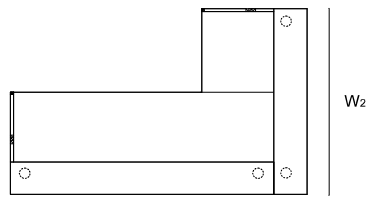

W1

INDEX SYMBOL	DIMENSIONS / ABMESSUNGEN [mm]									COMMENTS / BEMERKUNGEN / REMARQUES
	W <sub>1</sub>	W <sub>2</sub>	D <sub>1</sub>	D <sub>2</sub>	H		kg	m <sup>3</sup>	pcs	
<b>LZG42</b>	2480	1600	-	-	1146		265.9	2.811	15	

DESCRIPTION / LEGENDE / LÉGENDE:

net weight / Nettogewicht / poids net

volume / Volumen / le volume

number of packages / Stückzahl der Pakete / nombre de colis



RECEPTION DESK SYSTEMS / EMPFANGSTHEKEN-SYSTEME / CONFIGURATIONS DES BANQUES

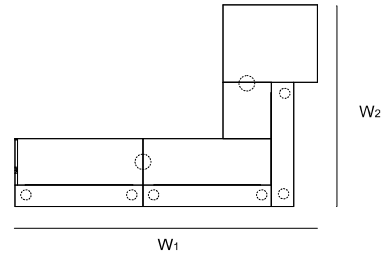
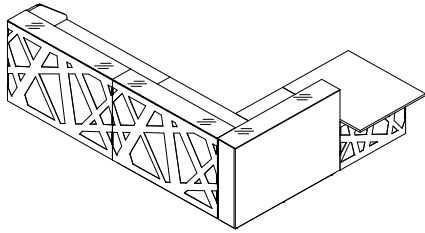

LZG16M+2xLZG16+LZG10+LZK01+LZN51+LZB16M+2xLZB16+3xNE41

INDEX SYMBOL	DIMENSIONS / ABMESSUNGEN [mm]									COMMENTS / BEMERKUNGEN / REMARQUES
	W <sub>1</sub>	W <sub>2</sub>	D <sub>1</sub>	D <sub>2</sub>	H		kg	m <sup>3</sup>	pcs	
<b>LZG58</b>	3808	2880	-	-	1146		435.2	4.215	31	

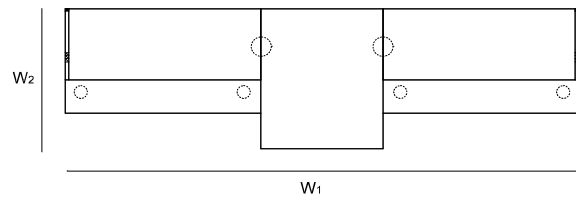
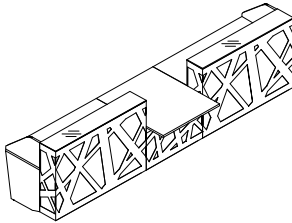

<sup>16</sup> <sup>16</sup> 2xNE41      <sup>16</sup> <sup>16</sup>  
<sup>16</sup> <sup>16</sup> 3xNE41      <sup>22</sup> <sup>22</sup>  
LZN51+LZG22+LZB22+4xNE41+LZG10+LZG22+LZB22+LZK01

INDEX SYMBOL	DIMENSIONS / ABMESSUNGEN [mm]									COMMENTS / BEMERKUNGEN / REMARQUES
	W <sub>1</sub>	W <sub>2</sub>	D <sub>1</sub>	D <sub>2</sub>	H		kg	m <sup>3</sup>	pcs	
<b>LZG52</b>	4200	1180	-	-	1146		329.8	3.034	23	
<b>LZG53</b>	4800	1180	-	-	1146		363.3	3.433	24	
<b>LZG54</b>	5400	1180	-	-	1146		396.8	3.831	25	

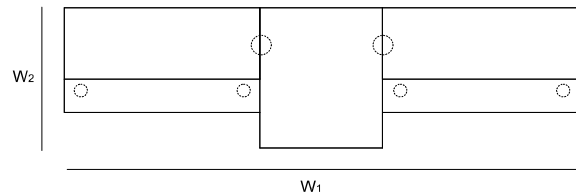
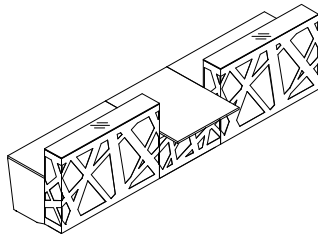

LZN51+LZG16+LZB16+NE41+LZG10+NE41+LZG16+LZB16

INDEX SYMBOL	DIMENSIONS / ABMESSUNGEN [mm]									COMMENTS / BEMERKUNGEN / REMARQUES
	W <sub>1</sub>	W <sub>2</sub>	D <sub>1</sub>	D <sub>2</sub>	H		kg	m <sup>3</sup>	pcs	
<b>LZG55</b>	4200	1180	-	-	1146		322.8	3.015	22	

DESCRIPTION / LEGENDE / LÉGENDE:

net weight / Nettogewicht / poids net

volume / Volumen / le volume

number of packages / Stückzahl der Pakete / nombre de colis



RECEPTION DESK SYSTEMS / EMPFANGSTHEKEN-SYSTEME / CONFIGURATIONS DES BANQUES

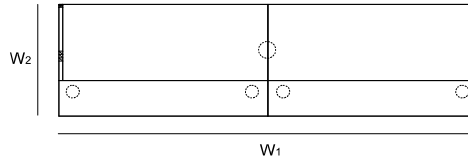
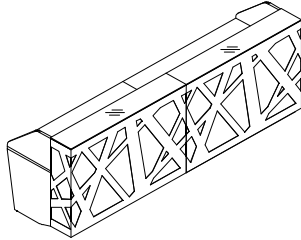

16 16 1xNE41 16 16  
16 16 2xNE41 22 22  
LZK01+LZN51+LZG22+LZB22+3xNE41+LZG22+LZB22

INDEX SYMBOL	DIMENSIONS / ABMESSUNGEN [mm]						⚖️	📦	📦		COMMENTS / BEMERKUNGEN / REMARQUES
	W <sub>1</sub>	W <sub>2</sub>	D <sub>1</sub>	D <sub>2</sub>	H						
<b>LZG60</b>	3200	880	-	-	1146		243.3	2.462	17		
<b>LZG61</b>	3800	880	-	-	1146		276.8	2.860	18		
<b>LZG62</b>	4400	880	-	-	1146		310.3	3.258	19		

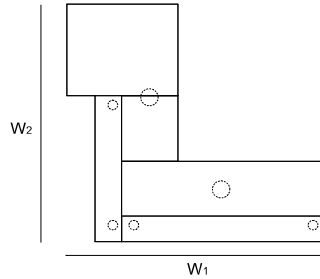
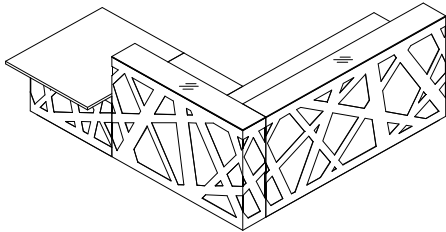

LZN51+LZG10+NE41+LZG16+LZB16M+LZG22+LZB22+NE41

INDEX SYMBOL	DIMENSIONS / ABMESSUNGEN [mm]						⚖️	📦	📦		COMMENTS / BEMERKUNGEN / REMARQUES
	W <sub>1</sub>	W <sub>2</sub>	D <sub>1</sub>	D <sub>2</sub>	H						
<b>LZG64</b>	2600	2780	-	-	1146		346.8	3.365	22		

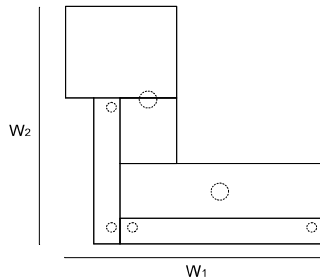
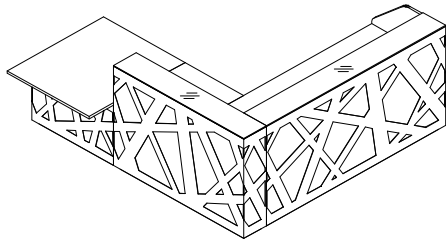

LZN51+LZG10+NE41+LZG16+LZB16M+LZG22+LZB22+NE41+LZK01

INDEX SYMBOL	DIMENSIONS / ABMESSUNGEN [mm]						⚖️	📦	📦		COMMENTS / BEMERKUNGEN / REMARQUES
	W <sub>1</sub>	W <sub>2</sub>	D <sub>1</sub>	D <sub>2</sub>	H						
<b>LZG63</b>	2600	2780	-	-	1146		353.8	3.384	23		

DESCRIPTION / LEGENDE / LÉGENDE:

⚖️ net weight / Nettogewicht / poids net

📦 volume / Volumen / le volume

📦 number of packages / Stückzahl der Pakete / nombre de colis





PRODUCT ILLUSTRATION / PRODUKTANSICHT UND SKIZZE / VUE DE PRODUIT	DIMENSIONS / ABMESSUNGEN [mm]			INDEX SYMBOL						COMMENTS / BEMERKUNGEN / REMARQUES
	WIDTH / BREITE / LARGEUR	DEPTH / TIEFE / PROFONDEUR	HEIGHT / HÖHE / HAUTEUR			kg	m3	pcs		

**ELEMENTS / BAUTEILE / ÉLÉMENTS COMPOSANTS**

	1600	280	1146	<b>LZG16M</b>		93.5	1.147	4		
	1600	280	1146	<b>LZG16</b>		91.5	1.147	4		
	2200	280	1146	<b>LZG22</b>		116.5	1.527	4		
	1000	1180	740	<b>LZG10</b>		85.0	0.555	5		
	720	600	28	<b>LZB16M</b>		10.4	0.017	3		
	1320	600	28	<b>LZB22M</b>		18.1	0.031	4		
	1600	600	28	<b>LZB16</b>		18.4	0.049	3		
	2200	600	28	<b>LZB22</b>		25.4	0.050	3		
	600	28	397	<b>LZK01</b>		7.0	0.020	1		
	600	28	712	<b>LZN51</b>		15.0	0.035	1		
	40	40	712	<b>NE41</b>		1.5	0.017	1		straight leg / Rundfuß / pied tube

DESCRIPTION / LEGENDE / LÉGENDE:

net weight / Nettogewicht / poids net

volume / Volumen / le volume

number of packages / Stückzahl der Pakete / nombre de colis



PRODUCT ILLUSTRATION / PRODUKTANSICHT UND SKIZZE / VUE DE PRODUIT	DIMENSIONS / ABMESSUNGEN [mm]			INDEX SYMBOL						COMMENTS / BEMERKUNGEN / REMARQUES
	WIDTH / BREITE / LARGEUR	DEPTH / TIEFE / PROFONDEUR	HEIGHT / HÖHE / HAUTEUR			kg	m3	pcs		

**ELEMENTS / BAUTEILE / ÉLÉMENTS COMPOSANTS**

PRODUCT ILLUSTRATION	WIDTH	DEPTH	HEIGHT	INDEX SYMBOL		kg	m3	pcs		COMMENTS
	460	70	87	<b>E64</b>		0.0	0.000	0		horizontal cable tray 09-aluminum / Kabelkanal 09 - Aluminium / bac à câble - 09 aluminium

DESCRIPTION / LEGENDE / LÉGENDE:

net weight / Nettogewicht / poids net

volume / Volumen / le volume

number of packages / Stückzahl der Pakete / nombre de colis