

STANDARD STORAGE / STANDARD SCHRANKSYSTEME / RENGEMENTS STANDARD

PEDESTALS / CONTAINER / CAISSONS

Pencil tray Separatschublade Materialauszug Plumier intégré

Body Korpus Corps

MFC / Melaminplatte /
Panneau mélaminé
18mm

Metal drawers Schubladen Tiroir

- silent closing as an option, roll runners with 25 kg maximum acceptable load, extraction 80%
- "silent system" als Option
Rollenführungsschiene mit einer Belastung von max. 25kg. Auszug 80%.
- Glissières a galets, fermeture silencieuse en option, Glissières a billes en option. Charge jusqu' a 25 kg. Extraction 80%.

Pedestals with filing drawers equipped with counterweight to ensure the stability of the pedestals

Im Container mit Hängeregisterschublade wurde Gegengewicht zugegeben, um die Stabilität des Containers zu verbessern

Caissons avec tiroir DS. équipés d'un contrepoids, afin d'assurer la stabilité de caissons

Top Oberplatte Plateau

MFC / Melaminplatte /
Panneau mélaminé / or / oder / ou / HPL / HPL /
18mm / stratifié brillant

- central lock with Anti Tilt mechanism (only one drawer may be opened at time), foldable key
- Zentralverschluss mit Blockierung gegen das gleichzeitige Ausfahren von mehreren Schubladen, Klappschlüssel
- clé gainée articulée. Serrure centralisée, assure la fermeture de l'ensemble des tiroirs

Front

MFC / Melaminplatte /
Panneau mélaminé / or / oder / ou / HPL / HPL /
18mm / stratifié brillant

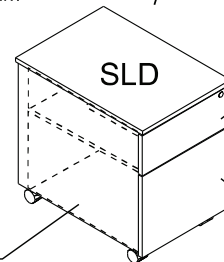

Extraction 80%
Auszug 80%
Extraction 80%

Extraction 100%
Vollauszug 100%
Extraction 100%

Filing drawer Aktenschublade Tiroir avec DS

- silent closing as an option, metal insert, foolscap and A4 ball runners with 35 kg maximum acceptable load.
- Metallschubladen mit "silent system", Kugelführungsschiene mit einer Belastung von max. 35kg.
- tiroir en metal, glissières télescopiques à billes, charge jusqu'à 35 kg.

PEDESTAL KDT / CONTAINER KDT / CAISSON KDT

Body Korpus Corps

MFC / Melaminplatte /
Panneau mélaminé
18mm

Casters Rollen Roulettes

- two with locking
- Bremsrollen, 2 Stück
- dont deux équipés de freins
ø 50mm

Metal drawers Metallschubladen Tiroirs en metal

- silent closing as an option
Roll runners with 25 kg maximum acceptable load. Extraction 80%.
- "Silent-system" als Option
Rollenführungsschiene mit einer Belastung von max. 25kg. 80% Auszug.
- Glissières a galets, fermeture silencieuse en option, Glissières a billes en option. Charge jusqu' a 25 kg. Extraction 80%.

Top Oberplatte Top

MFC / Melaminplatte /
Panneau mélaminé
18mm

- Central lock with Anti Tilt mechanism (only one drawer may be opened at time), foldable key.
- Zentralverschluss mit Blockierung gegen das gleichzeitige Ausfahren von mehreren Schubladen, Klappschlüssel
- clé gainée articulée, serrure centralisée, assure la fermeture de l'ensemble des tiroirs

Front

MFC / Melaminplatte /
Panneau mélaminé
18mm

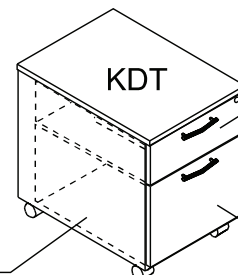

Extraction 80%
80% Auszug
Extraction 80%

Extraction 100%
Vollauszug 100%
Extraction 100%

Filing drawer Aktenschublade Tiroir vec DS.

Pedestals with filing drawers equipped with counterweight to ensure the stability of the pedestals

Im Container mit Hängeregisterschublade wurde Gegengewicht zugegeben, um die Stabilität des Containers zu verbessern

Caissons avec tiroir DS équipés d'un contrepoids, afin d'assurer la stabilité de caissons

STANDARD STORAGEES / STANDARD SCHRANKSYSTEME / RENGEMENTS STANDARD

TECHNICAL SPECIFICATION / TECHNISCHE BESCHREIBUNG / DESCRIPTION TECHNIQUE

DESK HEIGHT PEDESTAL / CONTAINER / CAISSON HAUTEUR BUREAU

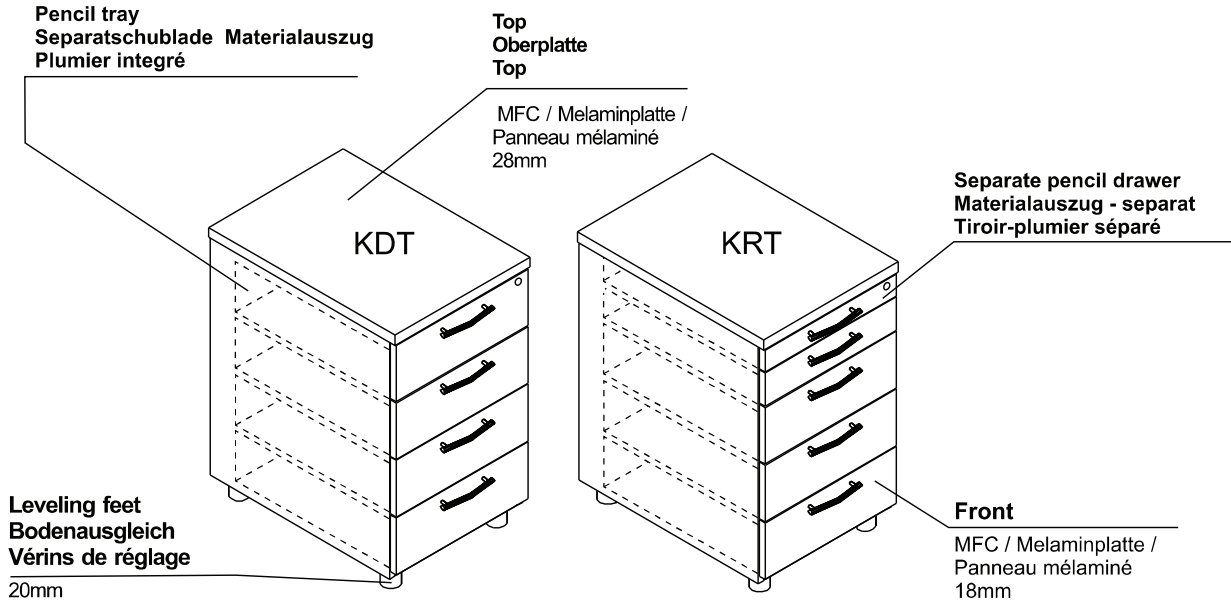

STORAGEES / SCHRÄNKE / RANGEMENTS

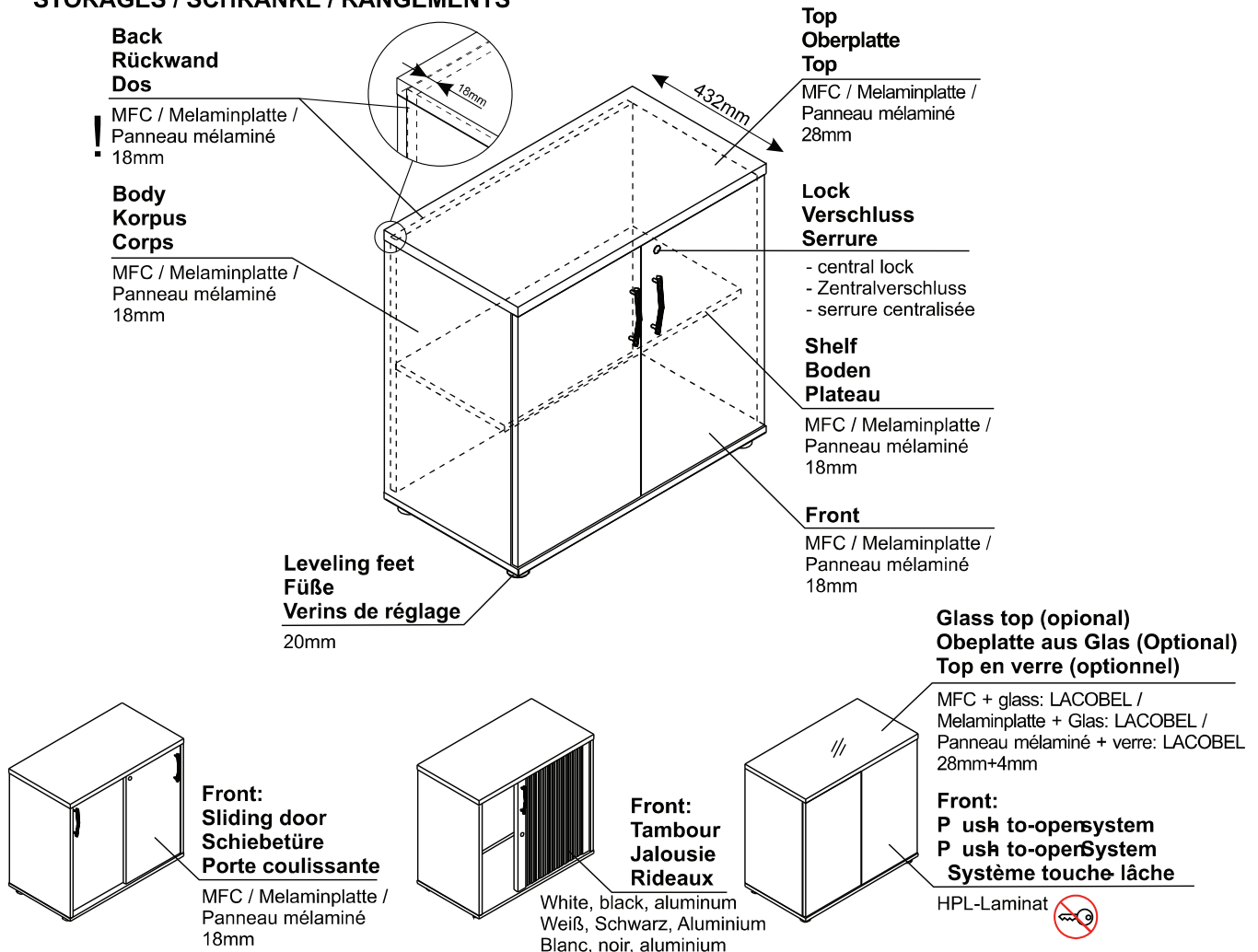

STANDARD STORAGES / STANDARD SCHRANKSYSTEME / RENGEMENTS STANDARD

TECHNICAL SPECIFICATION / TECHNISCHE BESCHREIBUNG / DESCRIPTION TECHNIQUE

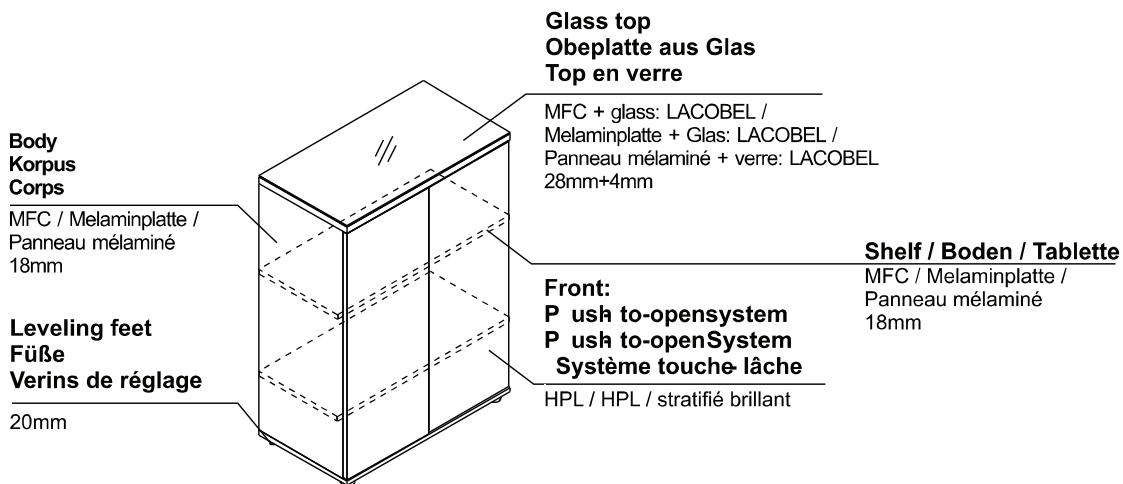

Pedestals cargo
Container cargo
Caissons cargo

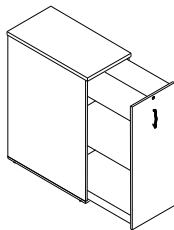

Manager storage
Sideboard
Desserte de manager

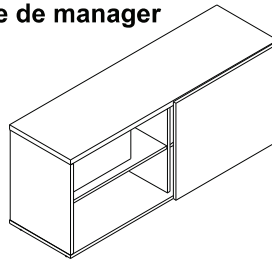

METAL SHELVES / METALLFACHBODEN / TABLETTES EN METAL

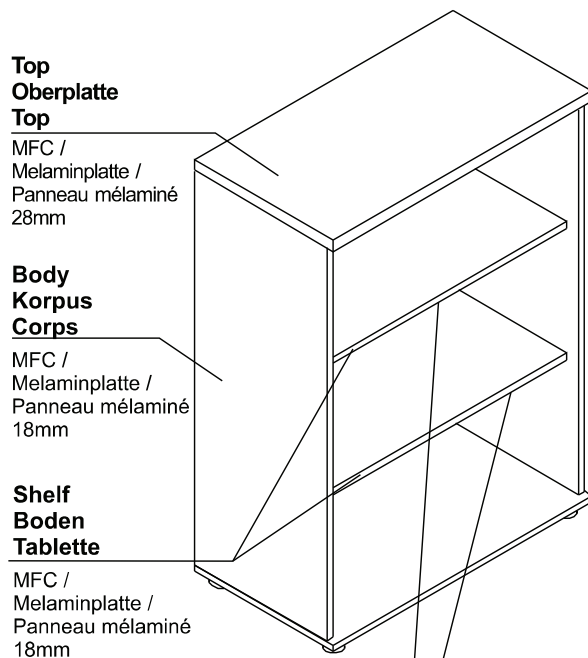

Metal shelves (optional)
Metallfachboden (Optional)
Tablettes en metal (optionnel)

- 09-aluminium, filing shelf, max load 41kg
- Farbe 09-aluminium, Aktenregal, Belastung von 41kg
- 09-aluminium, pour DS, charge 41kg

GLASS DOOR / GLASTÜR / PORTE EN

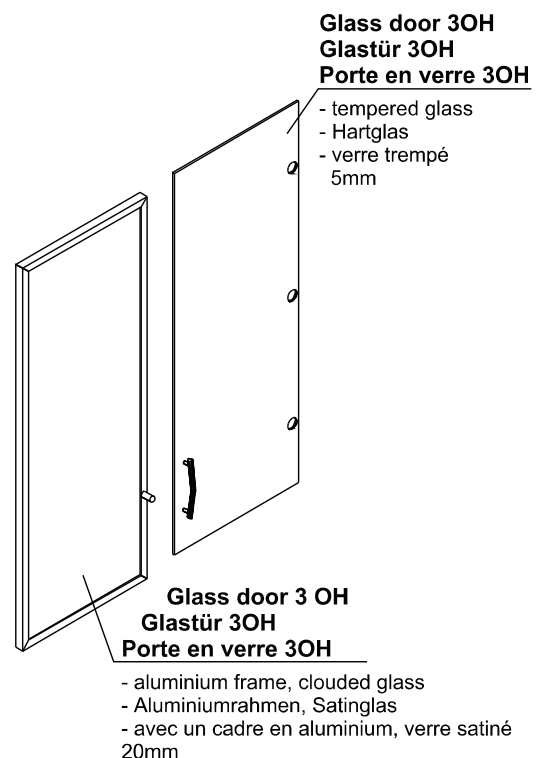

STANDARD STORAGEES / STANDARD SCHRANKSYSTEME / RENGEMENTS STANDARD

TECHNICAL SPECIFICATION / TECHNISCHE BESCHREIBUNG / DESCRIPTION TECHNIQUE

ZS01

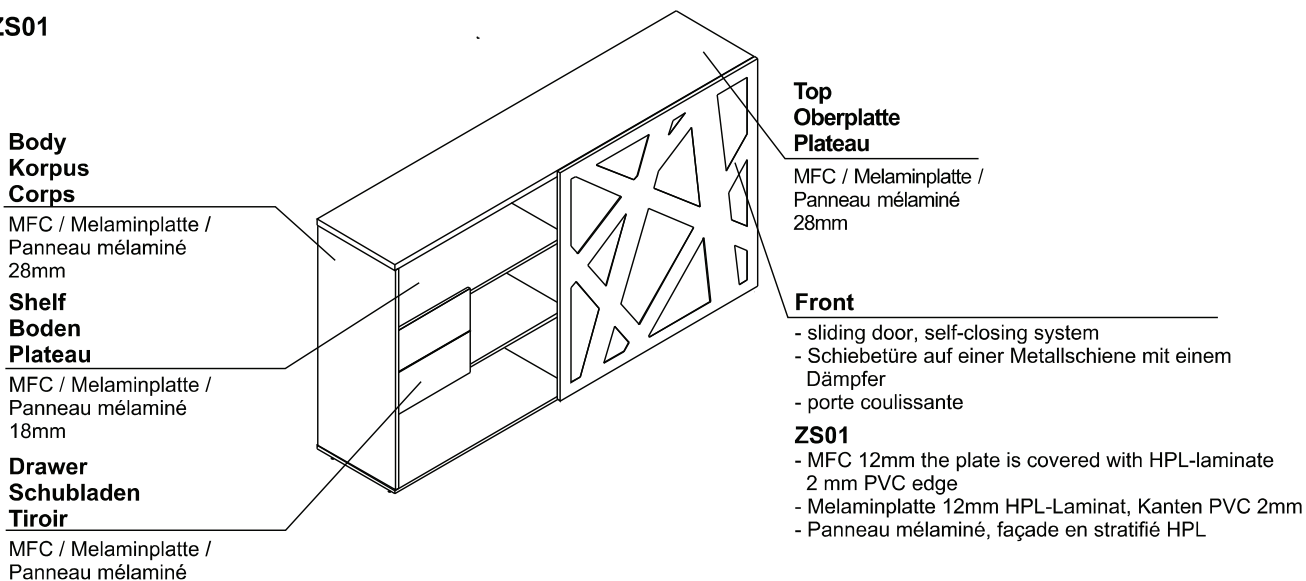

STORAGEES / SCHRÄNKE / RANGEMENTS

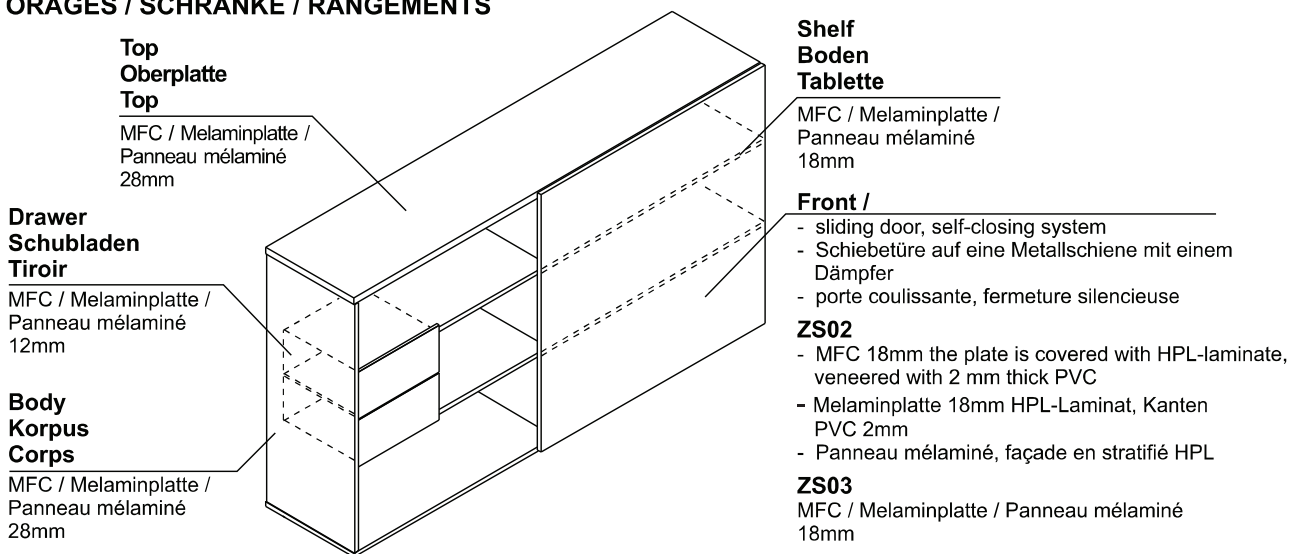

STANDARD STORAGEES / STANDARD SCHRANKSYSTEME / RENGEMENTS STANDARD

FINISHES / FARBEN / FINITIONS

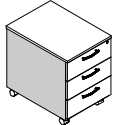
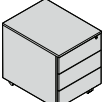
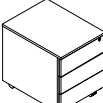
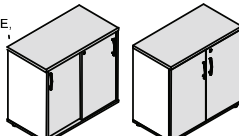
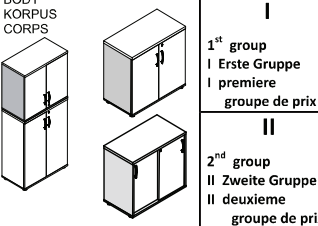
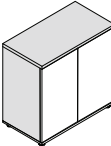
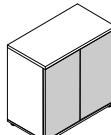
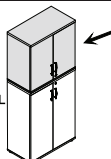
<p>TOP, FRONT OBERPLATTE, FRONT TOP, FRONT</p> 	<p>14 - BEECH BUCHE HETRE</p> <p>31 - CANADIAN OAK KANADISCHE EICHE CHENE CANADIEN</p> <p>34 - CHESTNUT WENGE WENGE</p> <p>39 - POLAR BIRCH POLARBIERKE BOULEAU CLAIR</p> <p>64 - COCOA COCOA CACAO</p> <p>67 - WHITE PASTEL WEIß PASTELL BLANC PASTEL</p> <p>106 - LOWLAND NUT NUSSBAUM NOYER</p>
<p>BODY KORPUS CORPS</p> 	<p>I 1st group I Erste Gruppe I premiere groupe de prix</p> <p>26 - ALUMINIUM SATINATO ALUMINIUM SATINATO ALUMINIUM SATINE</p> <p>67 - WHITE PASTEL WEIß PASTELL BLANC PASTEL</p> <hr/> <p>II 2nd group II Zweite Gruppe II deuxieme groupe de prix</p> <p>14 - BEECH BUCHE HETRE</p> <p>31 - CANADIAN OAK KANADISCHE EICHE CHENE CANADIEN</p> <p>34 - CHESTNUT WENGE WENGE</p> <p>39 - POLAR BIRCH POLARBIERKE BOULEAU CLAIR</p> <p>64 - COCOA COCOA CACAO</p> <p>67 - WHITE PASTEL WEIß PASTELL BLANC PASTEL</p> <p>106 - LOWLAND NUT NUSSBAUM NOYER</p>
<p>PEDESTALS HPL CONTAINER HPL CAISSONS STRATIFIE</p>  <p>SLD12HT, SLD13HT</p>	<p>HPL - FRONT, COUNTER TOP HPL - FRONT, OBERPLATTE STRATIFIE - FRONT, TOP</p> <p>BODY KORPUS CORPS</p> <p>HPL - FRONT, COUNTER TOP HPL - FRONT, OBERPLATTE STRATIFIE - FRONT, TOP</p> <p>BODY KORPUS CORPS</p> <p>73 - HIGH GLOSS WHITE WEIß GLANZ BLANC BRILLANT</p> <p>67 - WHITE PASTEL WEIß PASTELL BLANC PASTEL</p> <p>101 - HIGH GLOSS BLACK SHWARZ GLANZ NOIR BRILLANT</p> <p>08 - BLACK SCHWARZ NOIR</p>
<p>PEDESTALS CONTAINER CAISSONS</p>  <p>SLD12, SLD13</p>	<p>67 - WHITE PASTEL WEIß PASTELL BLANC PASTEL</p> <p>08 - BLACK SCHWARZ NOIR</p>
<p>TOP, FRONT OBERPLATTE, FRONT TOP, FRONT</p> 	<p>14 - BEECH BUCHE HETRE</p> <p>31 - CANADIAN OAK KANADISCHE EICHE CHENE CANADIEN</p> <p>34 - CHESTNUT WENGE WENGE</p> <p>39 - POLAR BIRCH POLARBIERKE BOULEAU CLAIR</p> <p>64 - COCOA COCOA CACAO</p> <p>67 - WHITE PASTEL WEIß PASTELL BLANC PASTEL</p> <p>106 - LOWLAND NUT NUSSBAUM NOYER</p>
<p>BODY KORPUS CORPS</p> 	<p>I 1st group I Erste Gruppe I premiere groupe de prix</p> <p>26 - ALUMINIUM SATINATO ALUMINIUM SATINATO ALUMINIUM SATINE</p> <p>67 - WHITE PASTEL WEIß PASTELL BLANC PASTEL</p> <hr/> <p>II 2nd group II Zweite Gruppe II deuxieme groupe de prix</p> <p>14 - BEECH BUCHE HETRE</p> <p>31 - CANADIAN OAK KANADISCHE EICHE CHENE CANADIEN</p> <p>34 - CHESTNUT WENGE WENGE</p> <p>39 - POLAR BIRCH POLARBIERKE BOULEAU CLAIR</p> <p>64 - COCOA COCOA CACAO</p> <p>67 - WHITE PASTEL WEIß PASTELL BLANC PASTEL</p> <p>106 - LOWLAND NUT NUSSBAUM NOYER</p>
<p>TOP AND BODY OBERPLATTE UND KORPS TOP ET CORPS</p> 	<p>67 - WHITE PASTEL WEIß PASTELL BLANC PASTEL</p> <p>08 - BLACK SCHWARZ NOIR</p>
<p>FRONT HPL FRONT HPL FRONT STRATIFIE</p> 	<p>72 - HIGH GLOSS LIME GRÜN GLANZ VERT BRILLANT</p> <p>73 - HIGH GLOSS WHITE WEIß GLANZ BLANC BRILLANT</p> <p>74 - HIGH GLOSS ORANGE ORANGE GLANZ ORANGE BRILLANT</p> <p>82 - HIGH GLOSS RED ROT GLANZ ROUGE BRILLANT</p> <p>101 - HIGH GLOSS BLACK SHWARZ GLANZ NOIR BRILLANT</p>
<p>UPPER STORAGEES / ANSÄTZE / REHAUSSE A SUSPENDRE</p>  <p>TOP, FRONT, BOTTOM OBERPLATTE, FRONT, SOCKEL TOP, FRONT, FOND</p>	<p>14 - BEECH BUCHE HETRE</p> <p>31 - CANADIAN OAK KANADISCHE EICHE CHENE CANADIEN</p> <p>34 - CHESTNUT WENGE WENGE</p> <p>39 - POLAR BIRCH POLARBIERKE BOULEAU CLAIR</p> <p>64 - COCOA COCOA CACAO</p> <p>67 - WHITE PASTEL WEIß PASTELL BLANC PASTEL</p> <p>106 - LOWLAND NUT NUSSBAUM NOYER</p>

STANDARD STORAGEES / STANDARD SCHRANKSYSTEME / RENGEMENTS STANDARD

FINISHES / FARBEN / FINITIONS

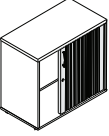
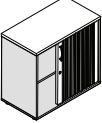
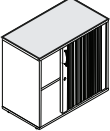
	<p>08 – BLACK SCHWARZ NOIR</p> <p>30 – WHITE WEIß BLANC</p> <p>26 – ALUMINUM SATINATO ALUMINIUM SATINATO ALUMINIUM SATINE</p>								
	<table border="0"> <tr> <td data-bbox="328 517 475 685"> <p>I</p> <p>1st group I – Erste Gruppe I – première groupe de prix</p> </td> <td data-bbox="475 517 651 685"> <p>08 – BLACK SCHWARZ NOIR</p> <p>67 – WHITE PASTEL WEIß PASTELL BLANC PASTEL</p> </td> <td data-bbox="651 517 1412 685"> <p>26 – ALUMINUM SATINATO ALUMINIUM SATINATO ALUMINIUM SATINE</p> </td> </tr> <tr> <td data-bbox="328 685 475 846"> <p>II</p> <p>2nd group II – Zweite Gruppe II – deuxième groupe de prix</p> </td> <td data-bbox="475 685 651 846"> <p>14 – BEECH BUCHE HETRE</p> <p>31 – CANADIAN OAK KANADISCHE EICHE CHENE CANADIEN</p> </td> <td data-bbox="651 685 1412 846"> <p>34 – CHESTNUT WENGE WENGE</p> <p>39 – POLAR BIRCH POLARBIERKE BOULEAU CLAIR</p> <p>64 – COCOA COCOA CACAO</p> <p>106 – LOWLAND NUT NUSSBAUM NOYER</p> </td> </tr> </table>	<p>I</p> <p>1st group I – Erste Gruppe I – première groupe de prix</p>	<p>08 – BLACK SCHWARZ NOIR</p> <p>67 – WHITE PASTEL WEIß PASTELL BLANC PASTEL</p>	<p>26 – ALUMINUM SATINATO ALUMINIUM SATINATO ALUMINIUM SATINE</p>	<p>II</p> <p>2nd group II – Zweite Gruppe II – deuxième groupe de prix</p>	<p>14 – BEECH BUCHE HETRE</p> <p>31 – CANADIAN OAK KANADISCHE EICHE CHENE CANADIEN</p>	<p>34 – CHESTNUT WENGE WENGE</p> <p>39 – POLAR BIRCH POLARBIERKE BOULEAU CLAIR</p> <p>64 – COCOA COCOA CACAO</p> <p>106 – LOWLAND NUT NUSSBAUM NOYER</p>		
<p>I</p> <p>1st group I – Erste Gruppe I – première groupe de prix</p>	<p>08 – BLACK SCHWARZ NOIR</p> <p>67 – WHITE PASTEL WEIß PASTELL BLANC PASTEL</p>	<p>26 – ALUMINUM SATINATO ALUMINIUM SATINATO ALUMINIUM SATINE</p>							
<p>II</p> <p>2nd group II – Zweite Gruppe II – deuxième groupe de prix</p>	<p>14 – BEECH BUCHE HETRE</p> <p>31 – CANADIAN OAK KANADISCHE EICHE CHENE CANADIEN</p>	<p>34 – CHESTNUT WENGE WENGE</p> <p>39 – POLAR BIRCH POLARBIERKE BOULEAU CLAIR</p> <p>64 – COCOA COCOA CACAO</p> <p>106 – LOWLAND NUT NUSSBAUM NOYER</p>							
	<table border="0"> <tr> <td data-bbox="475 846 651 925"> <p>08 – BLACK SCHWARZ NOIR</p> </td> <td data-bbox="651 846 762 925"> <p>31 – CANADIAN OAK KANADISCHE EICHE CHENE CANADIEN</p> </td> <td data-bbox="762 846 906 925"> <p>39 – POLAR BIRCH POLARBIERKE BOULEAU CLAIR</p> </td> <td data-bbox="906 846 1412 925"> <p>67 – WHITE PASTEL WEIß PASTELL BLANC PASTEL</p> </td> </tr> <tr> <td data-bbox="475 925 651 1021"> <p>14 – BEECH BUCHE HETRE</p> </td> <td data-bbox="651 925 762 1021"> <p>34 – CHESTNUT WENGE WENGE</p> </td> <td data-bbox="762 925 906 1021"> <p>64 – COCOA COCOA CACAO</p> </td> <td data-bbox="906 925 1412 1021"> <p>106 – LOWLAND NUT NUSSBAUM NOYER</p> </td> </tr> </table>	<p>08 – BLACK SCHWARZ NOIR</p>	<p>31 – CANADIAN OAK KANADISCHE EICHE CHENE CANADIEN</p>	<p>39 – POLAR BIRCH POLARBIERKE BOULEAU CLAIR</p>	<p>67 – WHITE PASTEL WEIß PASTELL BLANC PASTEL</p>	<p>14 – BEECH BUCHE HETRE</p>	<p>34 – CHESTNUT WENGE WENGE</p>	<p>64 – COCOA COCOA CACAO</p>	<p>106 – LOWLAND NUT NUSSBAUM NOYER</p>
<p>08 – BLACK SCHWARZ NOIR</p>	<p>31 – CANADIAN OAK KANADISCHE EICHE CHENE CANADIEN</p>	<p>39 – POLAR BIRCH POLARBIERKE BOULEAU CLAIR</p>	<p>67 – WHITE PASTEL WEIß PASTELL BLANC PASTEL</p>						
<p>14 – BEECH BUCHE HETRE</p>	<p>34 – CHESTNUT WENGE WENGE</p>	<p>64 – COCOA COCOA CACAO</p>	<p>106 – LOWLAND NUT NUSSBAUM NOYER</p>						

STANDARD STORAGEES / STANDARD SCHRANKSYSTEME / RENGEMENTS STANDARD



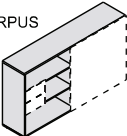
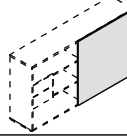
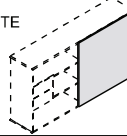
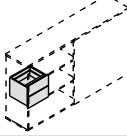
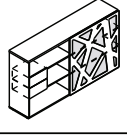
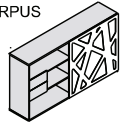
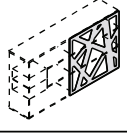
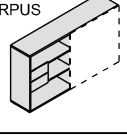
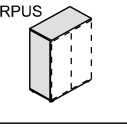
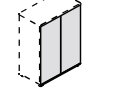



FINISHES / FARBEN / FINITIONS

TOP AND BODY OBERPLATTE UND KORPUS TOP ET CORPS ZS02 ZS03		67 – WHITE PASTEL WEIß PASTELL BLANC PASTEL
FRONT HPL FRONT HPL FRONT STRATIFIE ZS02		72 – HIGH GLOSS LIME GRÜN GLANZ VERT BRILLANT 74 – HIGH GLOSS ORANGE ORANGE GLANZ ORANGE BRILLANT 73 – HIGH GLOSS WHITE WEIß GLANZ BLANC BRILLANT 82 – HIGH GLOSS RED ROT GLANZ ROUGE BRILLANT
FRONT MFC FRONT MELAMINPLATTE FRONT PANNEAU MELAMINE ZS03		31 – CANADIAN OAK KANADISCHE EICHE CHENE CANADIAN 34 – CHESTNUT WENGE WENGE
DRAWER SCHUBLADEN TIROIR		67 – WHITE PASTEL WEIß PASTELL BLANC PASTEL
FRONT HPL FRONT HPL FRONT STRATIFIE		73 – HIGH GLOSS WHITE WEIß GLANZ BLANC BRILLANT
TOP AND BODY OBERPLATTE UND KORPUS TOP ET CORPS		67 – WHITE PASTEL WEIß PASTELL BLANC PASTEL
FRONT HPL FRONT HPL FRONT STRATIFIE		103 - WHITE STRUCTURE / WEIß STRUKTUR / BLANC STRUCTURE
TOP AND BODY OBERPLATTE UND KORPUS TOP ET CORPS		67 – WHITE PASTEL WEIß PASTELL BLANC PASTEL
TOP AND BODY OBERPLATTE UND KORPUS TOP ET CORPS		67 – WHITE PASTEL WEIß PASTELL BLANC PASTEL
FRONT HPL FRONT HPL FRONT STRATIFIE		72 – HIGH GLOSS LIME GRÜN GLANZ VERT BRILLANT 74 – HIGH GLOSS ORANGE ORANGE GLANZ ORANGE BRILLANT 73 – HIGH GLOSS WHITE WEIß GLANZ BLANC BRILLANT 82 – HIGH GLOSS RED ROT GLANZ ROUGE BRILLANT



STANDARD STORAGEES / STANDARD SCHRANKSYSTEME / RENGEMENTS STANDARD

PRODUCT ILLUSTRATION PRODUKTANSICHT UND SKIZZE VUE DE PRODUIT	DIMENSIONS / ABMESSUNGEN / DIMENSIONS (mm)			INDEX / SYMBOL	I - group I - Erste Gruppe I - première groupe de prix €	II - group II - Zweite Gruppe II - deuxième groupe de prix €				ECO
	WIDTH/ BREITE/ LARGEUR	DEPTH/ TIEFE/ PROFONDEUR	HEIGHT/ HÖHE/ HAUTEUR				kg	m ³	pcs	€

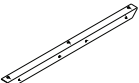
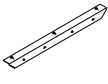

PEDESTALS KDT / CONTAINER KDT / CAISSONS KDT

	400	600	590	KDT12			33,1	0,158	1	3,243
	400	600	590	KDT13			25,8	0,162	1	2,528
	400	600	720 / 740	KDT63			23,2	0,196	1	2,273
	400	600	720 / 740	KDT64			33,7	0,217	1	3,302
	400	800	720 / 740	KDT73			28,9	0,26	1	2,832
	400	800	720 / 740	KDT74			40,2	0,273	1	3,939



CONNECTING ELEMENTS / BEFESTIGUNGSELEMENTE / ELEMENTS DE FIXATION

	620	30	30	E31			0,6	0,0007	1	0,058
	450	30	30	E32			0,4	0,0004	1	0,039
	330	30	30	E37			1,5	0,0004	1	0,147

ADDITIONAL CHARGE TO FEATURE/AUFPREIS FÜR SONDERAUSSTATTUNG/PLUSVALUE

FEATURE/ EIGENSCHAFT/ ATTRIBUT	PRODUCT / PRODUKT / PRODUITS									ECO	REMARKS BEMERKUNGEN REMARQUES
	KDT12	KDT13	KDT63	KDT64	KDT73	KDT74	kg	m ³	pcs	€	
silent closing system/ silent schließ system/ fermeture silencieuse	28,-	28,-	28,-	35,-	28,-	35,-	-	-	-		
Ball runners/ Kugelgleitschiene/ Glissières à billes	10,-	30,-	20,-	40,-	20,-	40,-	-	-	-		





LEGEND/LEGENDE/LÉGENDE:

 - net weight/Nettogewicht/poids net  - volume/Volumen/le volume  - number of packages/Anzahl der Pakete/nombre de colis

STANDARD STORAGEES / STANDARD SCHRANKSYSTEME / RENGEMENTS STANDARD

PRODUCT ILLUSTRATION PRODUKTANSICHT UND SKIZZE VUE DE PRODUIT	DIMENSIONS / ABMESSUNGEN / DIMENSIONS (mm)			INDEX / SYMBOL	I - group I - Erste Gruppe I - premiere groupe de prix €	II - group II - Zweite Gruppe II - deuxieme groupe de prix €				ECO
	WIDTH/ BREITE/ LARGEUR	DEPTH/ TIEFE/ PROFONDEUR	HEIGHT/ HÖHE/ HAUTEUR		kg	m ³	pcs	€		

PEDESTALS KRT / CONTAINER KRT/ CAISSONS KRT

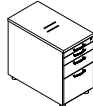
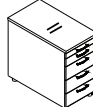
	400	600	590	KRT12			32,1	0,149	1	3,145
	400	600	590	KRT13			26,5	0,163	1	2,597
	400	600	720 / 740	KRT63			23,1	0,211	1	2,263
	400	600	720 / 740	KRT64			23,1	0,211	1	2,263
	400	800	720 / 740	KRT73			42,5	0,279	1	4,165
	400	800	720 / 740	KRT74			42,5	0,279	1	4,165



PILLOW / KISSEN / COUSSIN

	416	600	40	SKP13			1,6	0,016	1	0,197
---	-----	-----	----	--------------	--	--	-----	-------	---	-------



PEDESTALS CARGO / CONTAINER CARGO / CAISSONS CARGO

	400	800	1100	KDC80			65,2	0,138	2	6,389
---	-----	-----	------	--------------	--	--	------	-------	---	-------

ADDITIONAL CHARGE TO FEATURE/AUFPREIS FÜR SONDERAUSSTATTUNG/PLUSVALUE

FEATURE/ EIGENSCHAFT/ ATTRIBUT	PRODUCT / PRODUKT / PRODUITS									ECO	REMARKS BEMERKUNGEN REMARQUES
	KRT12	KRT13	KRT63	KRT64	KRT73	KRT74	kg	m ³	pcs	€	
silent closing system/ silent schließ system/ fermeture silencieuse	28,-	28,-	28,-	35,-	28,-	35,-	-	-	-		
Ball runners/ Kugelgleitchiene/ Glissières à billes	10,-	30,-	20,-	40,-	20,-	40,-	-	-	-		

LEGEND/LEGENDE/LÉGENDE:

 - net weight/Nettogewicht/poids net  - volume/Volumen/le volume  - number of packages/Anzahl der Pakete/nombre de colis

STANDARD STORAGEES / STANDARD SCHRANKSYSTEME / RENGEMENTS STANDARD

PRODUCT ILLUSTRATION PRODUKTANSICHT UND SKIZZE VUE DE PRODUIT	DIMENSIONS / ABMESSUNGEN / DIMENSIONS (mm)			INDEX / SYMBOL	I - group I - Erste Gruppe I - premiere groupe de prix €	II - group II - Zweite Gruppe II - deuxieme groupe de prix €				ECO
	WIDTH/ BREITE/ LARGEUR	DEPTH/ TIEFE/ PROFONDEUR	HEIGHT/ HÖHE/ HAUTEUR				kg	m ³	pcs	

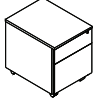
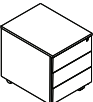

PEDESTAL / CONTAINER / CAISSON

	416	600	590	SLD12			30,9	0,191	1	3,028
	416	600	590	SLD13			30,9	0,191	1	3,028

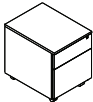
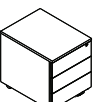

PEDESTAL HPL / CONTAINER HPL / CAISSONS STRATIFIE

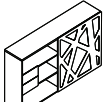
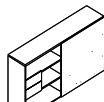
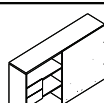
	416	600	590	SLD12HT			30,9	0,191	1	3,028
	416	600	590	SLD13HT			30,9	0,191	1	3,028



SLIDING DOOR STORAGEES / SACHRÄNKE MIT SCHIEBETÜR / ARMOIRES A PORTES COILISSANTES

	2000	434	1129	ZS01			111,8	0,35	4	10,956
	2000	434	1129	ZS02			111,8	0,35	4	10,956
	2000	434	1129	ZS03			111,8	0,35	4	10,956
	428	385	403	ZSZ01			9,6	0,074	4	0,940

ADDITIONAL CHARGE TO FEATURE/AUFPREIS FÜR SONDERAUSSTATTUNG/PLUSVALUE

FEATURE/ EIGENSCHAFT ATTRIBUT	PRODUKT / PRODUKT / PRODUITS							ECO	REMARKS BEMERKUNGEN REMARQUE
	SLD12	SLD13	SLD12HT	SLD13HT	kg	m ³	szt		
silent closing system/ silent schließ system/ fermeture silencieuse	28,-	28,-	28,-	28,-	-	-	-		
Ball runners/ Kugelgleitachiene/ Glissières à billes	10,-	30,-	10,-	30,-	-	-	-		



LEGEND/LEGENDE/LÉGENDE:

 - net weight/Nettogewicht/poids net  - volume/Volumen/le volume  - number of packages/Anzahl der Pakete/nombre de colis

STANDARD STORAGEES / STANDARD SCHRANKSYSTEME / RENGEMENTS STANDARD

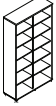
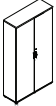
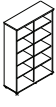
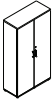

PRODUCT ILLUSTRATION PRODUKTANSICHT UND SKIZZE VUE DE PRODUIT	DIMENSIONS / ABMESSUNGEN / DIMENSIONS (mm)			INDEX / SYMBOL	I - group I - Erste Gruppe I - premiere groupe de prix €	II - group II - Zweite Gruppe II - deuxieme groupe de prix €				ECO
	WIDTH/ BREITE/ LARGEUR	DEPTH/ TIEFE/ PROFONDEUR	HEIGHT/ HÖHE/ HAUTEUR				kg	m ³	pcs	€

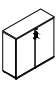
STORAGEES 1200mm WIDE / SCHRÄNKE UND REGALE 1200mm / ARMOIRES EN 1200mm



	1200	432	2185	A6506			100,9	0,24	2	11,201
 1	1200	432	2185	A6106			130,9	0,246	2	14,528
	1200	432	1833	A5506			86,4	0,189	2	9,591
 1	1200	432	1833	A5106			111,4	0,241	2	12,368
	1200	432	1129	A3506			56,5	0,133	2	6,271
	1200	432	1129	A3106			71,7	0,141	2	7,958

1 espagnolette lock
Stangenschloss
serrure espagnolette

ADDITIONAL CHARGE TO FEATURE/AUFPREIS FÜR SONDERAUSSTATTUNG/PLUSVALUE

FEATURE/ EIGENSCHAFT/ ATTRIBUT	PRODUCT / PRODUKT / PRODUITS									ECO	REMARKS BEMERKUNGEN REMARQUES
	A6506	A6106	A5506	A5106	A3506	A3106	kg	m ³	pcs	€	
Wide hinge/ Breitscharniere/ Charniere a grand	-	25,-	-	25,-	-	20,-	-	-	-		



LEGEND/LEGENDE/LÉGENDE:

 - net weight/Nettogewicht/poids net  - volume/Volumen/le volume  - number of packages/Anzahl der Pakete/nombre de colis

STANDARD STORAGEES / STANDARD SCHRANKSYSTEME / RENGEMENTS STANDARD

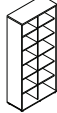
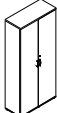
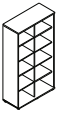
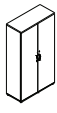

PRODUCT ILLUSTRATION PRODUKTANSICHT UND SKIZZE VUE DE PRODUIT	DIMENSIONS / ABMESSUNGEN / DIMENSIONS (mm)			INDEX / SYMBOL	I - group I - Erste Gruppe I - premiere groupe de prix €	II - group II - Zweite Gruppe II - deuxieme groupe de prix €				ECO
	WIDTH/ BREITE/ LARGEUR	DEPTH/ TIEFE/ PROFONDEUR	HEIGHT/ HÖHE/ HAUTEUR				kg	m ³	pcs	€

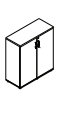
STORAGEES 1000mm WIDE / SCHRÄNKE UND REGALE 1000mm / ARMOIRES EN 1000mm



	1000	432	2185	A6505			89,1	0,182	2	9,890
 ¹	1000	432	2185	A6105			245,5	0,22	2	27,246
	1000	432	1833	A5505			77	0,139	2	8,550
 ¹	1000	432	1833	A5105			97,9	0,217	2	10,871
	1000	432	1129	A3505			49,7	0,095	1	5,518
	1000	432	1129	A3105			62,3	0,117	1	6,918

¹ espagnolette lock
Stangenschloss
serrure espagnolette

ADDITIONAL CHARGE TO FEATURE/AUFPREIS FÜR SONDERAUSSTATTUNG/PLUSVALUE

FEATURE/ EIGENSCHAFT/ ATTRIBUT	PRODUCT / PRODUKT / PRODUITS									ECO	REMARKS BEMERKUNGEN REMARQUES
	A6505	A6105	A5505	A5105	A3505	A3105	kg	m ³	pcs	€	
Wide hinge/ Breitscharniere/ Charniere a grand	-	25,-	-	25,-	-	20					

LEGEND/LEGENDE/LÉGENDE:

 - net weight/Nettogewicht/poids net  - volume/Volumen/le volume  - number of packages/Anzahl der Pakete/nombre de colis

STANDARD STORAGEES / STANDARD SCHRANKSYSTEME / RENGEMENTS STANDARD

PRODUCT ILLUSTRATION PRODUKTANSICHT UND SKIZZE VUE DE PRODUIT	DIMENSIONS / ABMESSUNGEN / DIMENSIONS (mm)			INDEX / SYMBOL	I - group I - Erste Gruppe I - première groupe de prix €	II - group II - Zweite Gruppe II - deuxième groupe de prix €	kg	m ³	pcs	ECO €
	WIDTH/ BREITE/ LARGEUR	DEPTH/ TIEFE/ PROFONDEUR	HEIGHT/ HÖHE/ HAUTEUR							

STORAGEES 800mm WIDE / SCHRÄNKE UND REGALE 800mm / ARMOIRES EN 800mm

	800	432	2185	A6504			66,9	0,158	1	7,423
1	800	432	2185	A6104			87,3	0,188	2	9,692
	800	432	1833	A5504			57	0,122	2	6,325
1	800	432	1833	A5104			72	0,187	3	8,279
	800	432	1833	A5404			64,5	0,149	3	7,159
	800	432	1833	A5304			67,6	0,148	3	7,505
2	800	602	1833	A6204			78,2	0,15	1	8,675

1 These storagees do not have espagnolette locks. Locks are available as an option for an additional cost of 40 EUR after discount.
In case of ordering a cabinet with a lock, please add a "Z" letter at the end of the product index. E.g. A5104Z

Der Stangenschloss gegen Aufpreis 40 EUR (EK-Preis) erhältlich. Am Ende des Indexes „Z“ schreiben,
z. B. A5104Z

Montage d'une serrure espagnolette simple pour un prix supplémentaire de 40 EUR net achat.
Pour commander une serrure veuillez mettre un Z à la fin du code du produit. P.ex. A5104Z

2 wardrobe with hanger bar
kleiderschrank mit stange
penderie, triangle

ADDITIONAL CHARGE TO FEATURE/AUFPREIS FÜR SONDERAUSSTATTUNG/PLUSVALUE

FEATURE/ EIGENSCHAFT/ ATTRIBUT	PRODUCT / PRODUKT / PRODUITS							kg	m ³	pcs	ECO €	REMARKS BEMERKUNGEN REMARQUES
	A6205	A6504	A6104	A5504	A5104	A5404	A5304					
Wide hinge/ Breitscharniere/ Charnière a grand	25,-	-	25,-	-	25,-	20,-	20,-					

LEGEND/LEGENDE/LÉGENDE:

- net weight/Nettogewicht/poids net - volume/Volumen/le volume - number of packages/Anzahl der Pakete/nombre de colis

STANDARD STORAGEES / STANDARD SCHRANKSYSTEME / RENGEMENTS STANDARD

PRODUCT ILLUSTRATION PRODUKTSANSICHT UND SKIZZE VUE DE PRODUIT	DIMENSIONS / ABMESSUNGEN / DIMENSIONS (mm)			INDEX / SYMBOL	I - group I - Erste Gruppe I - premiere groupe de prix €	II - group II - Zweite Gruppe II - deuxieme groupe de prix €				ECO
	WIDTH/ BREITE/ LARGEUR	DEPTH/ TIEFE/ PROFONDEUR	HEIGHT/ HÖHE/ HAUTEUR							



STORAGEES 800mm WIDE / SCHRÄNKE UND REGALE 800mm / ARMOIRES EN 800mm

 1	800	432	1833	A52P4			75,8	0,15	1	8,413
	800	432	1129	A3504			36,6	0,093	2	4,062
	800	432	1129	A3104			47,2	0,119	3	5,239
	800	432	1129	A3404			44,1	0,12	3	4,895
 2	800	432	1129	A3F04			50,7	0,42	1	5,627
	800	432	777	A2504			17,4	0,067	2	3,041
	800	432	777	A2104			34,9	0,94	3	3,873



1 These storagees do not have locks. wardrobe with slide-out hanger and shelves
Ohne Verschluss im Standard. Kleidung- und Aktenschrank mit Ausschiebstatange
Armoires ne sont pas equipées d'une serrure. kit penderie, tablettes melamine

2 with file drawers
Aktenschublade
dossiers suspendu

ADDITIONAL CHARGE TO FEATURE/AUFPREIS FÜR SONDERAUSSTATTUNG/PLUSVALUE

FEATURE/ EIGENSCHAFT/ ATTRIBUT	PRODUCT / PRODUKT / PRODUITS										ECO	REMARKS BEMERKUNGEN REMARQUES
	A52P4	A3504	A3104	A3404	A3F04	A2504	A2104					
Wide hinge/ Breitscharniere/ Charniere a grand	25,-	-	20,-	20,-	-	-	20,-					







LEGEND/LEGENDE/LÉGENDE:

 - net weight/Nettogewicht/poids net  - volume/Volumen/le volume  - number of packages/Anzahl der Pakete/nombre de colis

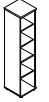
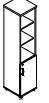
STANDARD STORAGEES / STANDARD SCHRANKSYSTEME / RENGEMENTS STANDARD

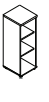

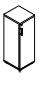
PRODUCT ILLUSTRATION PRODUKTANSICHT UND SKIZZE VUE DE PRODUIT	DIMENSIONS / ABMESSUNGEN / DIMENSIONS (mm)			INDEX / SYMBOL	I - group I - Erste Gruppe I - premiere groupe de prix €	II - group II - Zweite Gruppe II - deuxieme groupe de prix €				ECO
	WIDTH/ BREITE/ LARGEUR	DEPTH/ TIEFE/ PROFONDEUR	HEIGHT/ HÖHE/ HAUTEUR				kg	m ³	pcs	€

STORAGEES 400mm WIDE / SCHRÄNKE UND REGALE 400mm / ARMOIRES EN 400mm



	600	432	1833	A57P3			52,6	0,138	1	5,836
	400	432	1833	A5902			37,8	0,094	1	4,195
 1	400	432	1833	A58P2			41,3	0,094	1	4,584
 1	400	432	1833	A56P2			46,4	0,094	1	5,150
	400	432	1129	A3902			24,9	0,049	1	2,763
 1	400	432	1129	A38P2			28,5	0,057	1	3,163
 1	400	432	1129	A36P2			30	0,057	1	3,330
	400	432	777	A2902			18,4	0,037	1	2,042
 1	400	432	777	A26P2			21,7	0,043	1	2,408

1 right door
Tür rechts
porte droite

ADDITIONAL CHARGE TO FEATURE/AUFPREIS FÜR SONDERAUSSTATTUNG/PLUSVALUE

FEATURE/ EIGENSCHAFT/ ATTRIBUT	PRODUCT / PRODUKT / PRODUITS												ECO	REMARKS BEMERKUNGEN REMARQUES
	A57P3	A5902	A58P2	A56P2	A3902	A38P2	A36P2	A2902	A26P2	kg	m ³	pcs	€	
Wide hinge/ Breitscharniere/ Charniere a grand	25,-	-	20,-	25,-	-	20,-	20,-	-	20,-					





LEGEND/LEGENDE/LÉGENDE:

 - net weight/Nettogewicht/poids net  - volume/Volumen/le volume  - number of packages/Anzahl der Pakete/nombre de colis

STANDARD STORAGEES / STANDARD SCHRANKSYSTEME / RENGEMENTS STANDARD

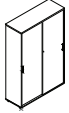

PRODUCT ILLUSTRATION PRODUKTANSICHT UND SKIZZE VUE DE PRODUIT	DIMENSIONS / ABMESSUNGEN / DIMENSIONS (mm)			INDEX / SYMBOL	I - group I - Erste Gruppe I - première groupe de prix €	II - group II - Zweite Gruppe II - deuxième groupe de prix €				ECO €
	WIDTH/ BREITE/ LARGEUR	DEPTH/ TIEFE/ PROFONDEUR	HEIGHT/ HÖHE/ HAUTEUR				kg	m ³	pcs	

SLIDING DOORS STORAGEES / SCHRÄNKE MIT SCHIEBETÜR / ARMOIRES A PORTES COULISSANTES

	1200	432	1833	A5P06			111,8	0,245	12,409	12,409
	1200	432	1129	A3P06			72,4	0,158	8,036	8,036
	800	432	740	A2P04			33,8	0,076	3,751	3,751
	1200	432	740	A2P06			49,5	0,104	5,494	5,494
 ¹	1200	432	750	A1P06			50	0,411	5,550	5,550

1 fixing to the wall necessary
an die Wand befestigen
rehausse à fixer au mur

LEGEND/LEGENDE/LÉGENDE:

 - net weight/Nettogewicht/poids net  - volume/Volumen/le volume  - number of packages/Anzahl der Pakete/nombre de colis

STANDARD STORAGEES / STANDARD SCHRANKSYSTEME / RENGEMENTS STANDARD

PRODUCT ILLUSTRATION PRODUKTANSICHT UND SKIZZE VUE DE PRODUIT	DIMENSIONS / ABMESSUNGEN / DIMENSIONS (mm)			INDEX / SYMBOL	I - group I - Erste Gruppe I - première groupe de prix €	II - group II - Zweite Gruppe II - deuxième groupe de prix €	 kg	 m ³	 pcs	ECO €
	WIDTH/ BREITE/ LARGEUR	DEPTH/ TIEFE/ PROFONDEUR	HEIGHT/ HÖHE/ HAUTEUR							

UPPER STORAGEES / ANSÄTZE / REHAUSSE A SUSPENDRE - 1 TABLETTE

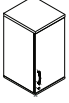
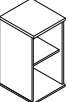
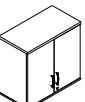
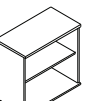

 ¹	400	432	750	A16P2			21,7	0,043	2,408	2,408
	400	432	750	A1902			18,4	0,037	2,060	2,060
	800	432	750	A1104			35,1	0,079	3,896	3,896
	800	432	750	A1504			28,7	0,061	3,185	3,185

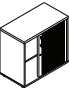
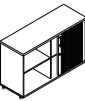
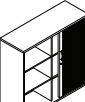
TAMBOUR STORAGEES / JALOUSIESCHRÄNKE / ARMOIRES A RIDEAUX



	800	434	740	A2Z04			31	0,303	3,441	3,441
	1200	434	740	A2Z06			44,4	0,463	4,928	4,928
	1200	434	1129	A3Z06			61,6	0,673	6,837	6,837

1 fixing to the wall necessary
an der Wand befestigen
rehausse à fixer au mur

ADDITIONAL CHARGE TO FEATURE/AUFPREIS FÜR SONDERAUSSTATTUNG/PLUSVALUE

FEATURE/ EIGENSCHAFT/ ATTRIBUT	PRODUCT / PRODUKT / PRODUITS				 kg	 m ³	 pcs	ECO €	REMARKS BEMERKUNGEN REMARQUES
	A16P2	A1902	A1104	A1504					
Wide hinge/ Breitscharniere/ Charnière a grand	20,-	-	20,-	-					





LEGEND/LEGENDE/LÉGENDE:

 - net weight/Nettogewicht/poids net  - volume/Volumen/le volume  - number of packages/Anzahl der Pakete/nombre de colis



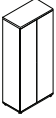
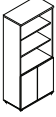



STANDARD STORAGEES / STANDARD SCHRANKSYSTEME / RENGEMENTS STANDARD

PRODUCT ILLUSTRATION PRODUKTANSICHT UND SKIZZE VUE DE PRODUIT	DIMENSIONS / ABMESSUNGEN / DIMENSIONS (mm)			INDEX / SYMBOL	I - group I - Erste Gruppe I - première groupe de prix €	II - group II - Zweite Gruppe II - deuxième groupe de prix €	 kg	 m ³	 pcs	ECO €
	WIDTH/ BREITE/ LARGEUR	DEPTH/ TIEFE/ PROFONDEUR	HEIGHT/ HÖHE/ HAUTEUR							

STORAGEES WITH HPL FRONT / SCHRÄNKE MIT HPL FRONT / ARMOIRES AVEC DES FACADES EN STRATIFIE

 1	800	432	1833	A5104H			72	0,17	3	7,992
 1	800	432	1833	A5404H			58,4	0,188	3	6,482
 1	800	432	1129	A3104H			47	0,123	3	5,217
 1	800	432	1129	A3404H			52,1	0,127	3	5,783
 1	800	432	777	A2104H			34	0,088	3	3,774



STORAGEES WITH HPL FRONT / SCHRÄNKE MIT HPL FRONT / ARMOIRES AVEC DES FACADES EN STRATIFIE

 1	800	432	1134	A3104HG			48,7	0,127	3	5,405
 1	800	432	1134	A3404HG			53,8	0,131	3	5,971
 1	800	432	782	A2104HG			35,6	0,092	3	3,951
 1	800	432	1134	A3504G			38,3	0,096	2	4,289
 1	800	432	782	A2504G			29,1	0,07	2	3,230
 2	800	432	33	A800GT			7,5	0,016	1	0,832

1 These storagees do not have locks.
Ohne Verschluss im Standard.
Armoires ne sont pas équipées d'une serrure.

2 MFC + glass Lacobel - white
Melaminplatte + Glas Lacobel - weiß
panneau mélaminé + verre Lacobel - blanc

LEGEND/LEGENDE/LÉGENDE:

 - net weight/Nettogewicht/poids net  - volume/Volumen/le volume  - number of packages/Anzahl der Pakete/nombre de colis

STANDARD STORAGEES / STANDARD SCHRANKSYSTEME / RENGEMENTS STANDARD

PRODUCT ILLUSTRATION PRODUKTANSICHT UND SKIZZE VUE DE PRODUIT	DIMENSIONS / ABMESSUNGEN / DIMENSIONS (mm)			INDEX / SYMBOL	I - group I - Erste Gruppe I - première groupe de prix €	II - group II - Zweite Gruppe II - deuxième groupe de prix €				ECO
	WIDTH/ BREITE/ LARGEUR	DEPTH/ TIEFE/ PROFONDEUR	HEIGHT/ HÖHE/ HAUTEUR		kg	m ³	pcs	€		

STORAGEES WIDE WITH METAL SHELVES / SCHRÄNKE UND REGALE MIT METALLFACHBODEN / ARMOIRES AVEC TABLETTES EN METAL

	1	1200	432	1833	A5506TM			88,9	0,189	2	9,868
	1	1200	432	1833	A5106TM			114,2	0,242	2	12,676
	2	1200	432	1129	A3506TM			57,6	0,134	1	6,394
	2	1200	432	1129	A3106TM			72,8	0,141	1	8,081
	1	1000	432	1833	A5505TM			79,1	0,148	2	8,780
	1	1000	432	1833	A5105TM			100,5	0,217	2	11,156
	2	1000	432	1129	A3505TM			50,6	0,095	1	5,617
	2	1000	432	1129	A3105TM			63,3	0,118	1	7,026

1 4 filling shelves in aluminum colour
Metallfachböden für Akten, 4 Stück, Farbe 09-Aluminium
quatre tablettes en métal pour dossiers suspendu, couleur aluminium

2 2 filling shelves in aluminum colour
Metallfachböden für Akten, 2 Stück, Farbe 09-Aluminium
deux tablettes en métal pour dossiers suspendu, couleur aluminium

ADDITIONAL CHARGE TO FEATURE/AUFPREIS FÜR SONDERAUSSTATTUNG/PLUSVALUE

FEATURE/ EIGENSCHAFT/ ATTRIBUT	PRODUCT / PRODUKT / PRODUITS											ECO	REMARKS BEMERKUNGEN REMARQUES
	A5506TM	A5106TM	A3506TM	A3106TM	A5505TM	A5105TM	A3505TM	A3105TM	kg	m ³	pcs	€	
Wide hinge/ Breitscharniere/ Charnière a grand	-	25,-	-	20,-	-	25,-	-	20,-					





LEGEND/LEGENDE/LÉGENDE:

- net weight/Nettogewicht/poids net - volume/Volumen/le volume - number of packages/Anzahl der Pakete/nombre de colis

STANDARD STORAGEES / STANDARD SCHRANKSYSTEME / RENGEMENTS STANDARD

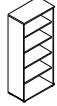
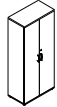
PRODUCT ILLUSTRATION PRODUKTANSICHT UND SKIZZE VUE DE PRODUIT	DIMENSIONS / ABMESSUNGEN / DIMENSIONS (mm)			INDEX / SYMBOL	I - group I - Erste Gruppe I - première groupe de prix	II - group II - Zweite Gruppe II - deuxième groupe de prix				ECO
	WIDTH/ BREITE/ LARGEUR	DEPTH/ TIEFE/ PROFONDEUR	HEIGHT/ HÖHE/ HAUTEUR				kg	m ³	pcs	€

STORAGEES WIDE WITH METAL SHELVES / SCHRÄNKE UND REGALE MIT METALLFACHBODEN / ARMOIRES AVEC TABLETTES EN METAL

	1	800	432	1833	A5504TM			52,9	0,167	2	5,872
	1	800	432	1833	A5104TM			73,7	0,15	1	8,180
	2	800	432	1129	A3504TM			45,6	0,105	2	5,061
	2	800	432	1129	A3104TM			56,2	0,132	3	6,238
	3	780	370	65	TM2			5	0,019	1	0,48

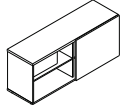

MANAGER STORAGE / SIEDBOARD / DESSERTTE DE MANAGER

		1400	432	600	A14M			67	0,196	3	7,437
---	--	------	-----	-----	------	--	--	----	-------	---	-------



- 1 4 filling shelves in aluminum colour
Metallfachböden für Akten, 4 Stück, Farbe 09-Aluminium
quatre tablettes en métal pour dossiers suspendu, couleur aluminium
- 2 2 filling shelves in aluminum colour
Metallfachböden für Akten, 2 Stück, Farbe 09-Aluminium
deux tablettes en métal pour dossiers suspendu, couleur aluminium
- 3 set of 2 shelves, aluminium colour
Metallfachböden für Akten,
2 Stück, Farbe 09-Aluminium
ensemble de deux tablettes
en métal pour dossiers
suspendu, couleur aluminium

for storagees /
für Schrank /
pour armoires:
800mm

ADDITIONAL CHARGE TO FEATURE/AUFPREIS FÜR SONDERAUSSTATTUNG/PLUSVALUE

FEATURE/ EIGENSCHAFT/ ATTRIBUT	PRODUCT / PRODUKT / PRODUITS							ECO	REMARKS BEMERKUNGEN REMARQUES
	A5504TM	A5104TM	A3504TM	A3104TM	kg	m ³	pcs	€	
Wide hinge/ Breitscharniere/ Charnière a grand	20,-	25,-	-	20,-					









LEGEND/LEGENDE/LÉGENDE:

 - net weight/Nettogewicht/poids net  - volume/Volumen/le volume  - number of packages/Anzahl der Pakete/nombre de colis

STANDARD STORAGE / STANDARD SCHRANKSYSTEME / RENGEMENTS STANDARD



PRODUCT ILLUSTRATION PRODUKTANSICHT UND SKIZZE VUE DE PRODUIT	DIMENSIONS / ABMESSUNGEN / DIMENSIONS (mm)			INDEX / SYMBOL	I - group I - Erste Gruppe I - première groupe de prix	II - group II - Zweite Gruppe II - deuxième groupe de prix				ECO
	WIDTH/ BREITE/ LARGEUR	DEPTH/ TIEFE/ PROFONDEUR	HEIGHT/ HÖHE/ HAUTEUR				kg	m ³	pcs	€

ADDITIONAL ELEMENTS FOR STORAGE / ERGÄNZUNGSELEMENTE / MEUBLES ET ELEMENTS SUPPLEMENTAIRES

 1	397	5	1050	AS31		-	5,7	0,033	1	0,635
 2	397	20	1050	AS29		-	4,4	0,022	1	0,491
 2	397	20	1050	AS30		-	4,4	0,022	1	0,491
 2	800	20	1050	AS300		-	9,6	0,037	1	1,062
 3	800	390	430	J21		-	15	0,154	1	1,666
 3	1200	390	430	J22		-	20,3	0,23	1	2,256
 3	800	390	430	J27		-	16,3	0,154	1	1,810
 4	710	600	600	S85		-	31,3	0,065	1	3,473

- 1 glass door 30H, 1pc, universal (left and right), tempered glass
Hartglastür 30H, 1 Stück, universell (links und rechts)
porte en verre, 1 pièce 2tablettes, universel (droit et gauche), porte, verre trempé
- 2 glass door 3 OH with aluminum frame, right door, clouded glass
Salinglastür 3OH Mit Aluminiumrahmen, rechts
porte 1 pièce, 2tablettes avec un cadre en aluminium, porte droite, verre satiné
- 3 26-aluminum satinato 67-white pastel
26-Aluminium Satinato 67-Weiß Pastell
26-aluminium satiné 67-blanc pastell
- 4 cabinet for photocopier, 26-aluminum satinato
Kopierer-Schrank 26-Aluminium Satinato
desserte à cases pour photocopieurs, 26-aluminium satiné

LEGEND/LEGENDE/LÉGENDE:

 - net weight/Nettogewicht/poids net  - volume/Volumen/le volume  - number of packages/Anzahl der Pakete/nombre de colis

BUDGET STORAGES / SCHRANKSYSTEME / RENGEMENTS ECONOMIQUES

TECHNICAL SPECIFICATION / TECHNISCHE BESCHREIBUNG / DESCRIPTION TECHNIQUE
STORAGES / SCHRÄNKE / ARMOIRES

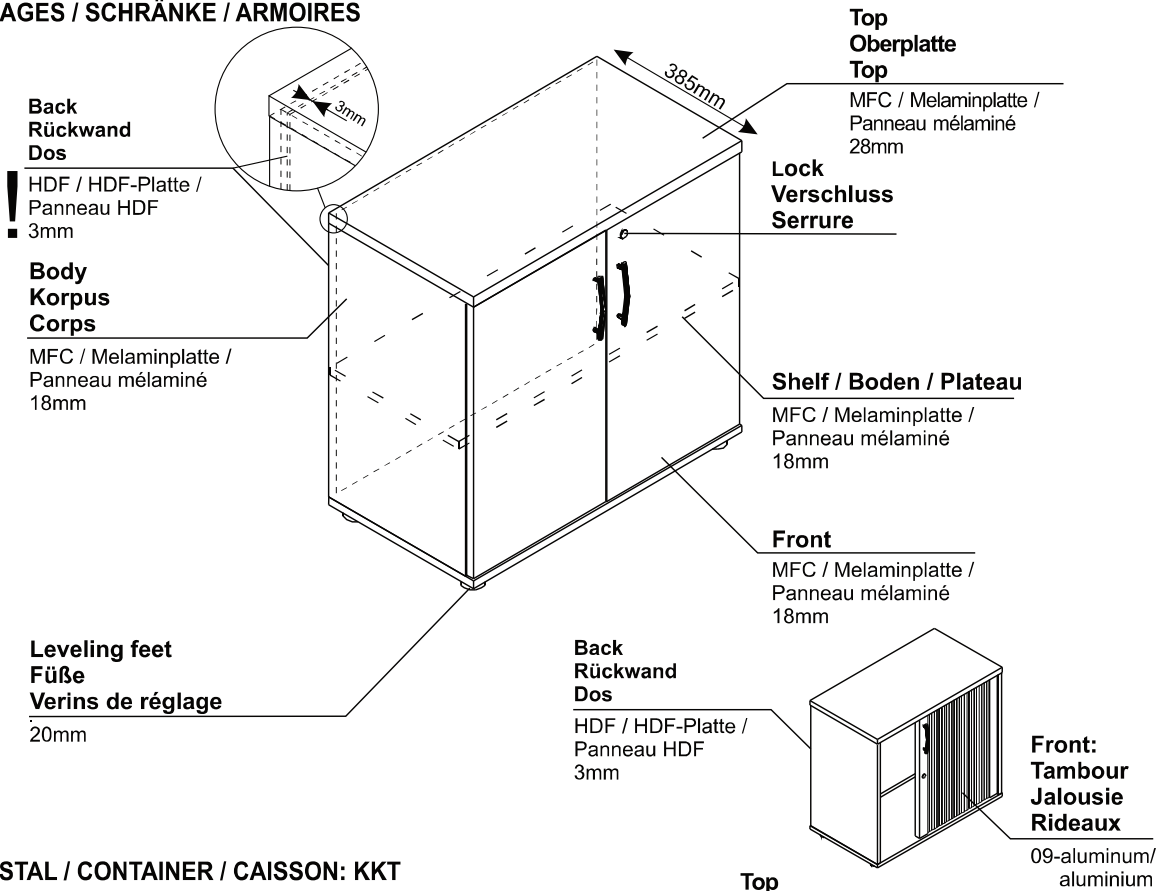

PEDESTAL / CONTAINER / CAISSON: KKT

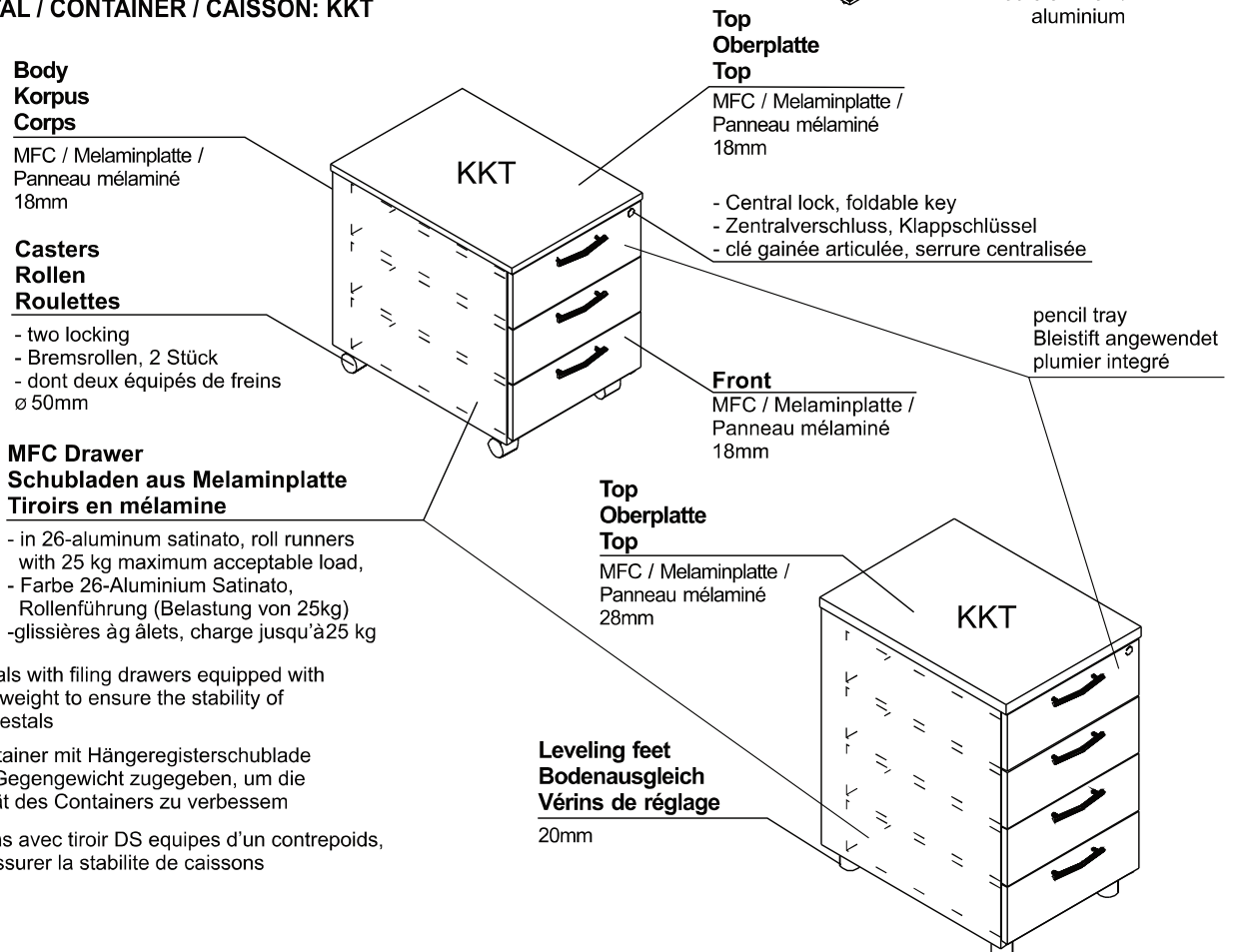

Pedestals with filing drawers equipped with counterweight to ensure the stability of the pedestals

Im Container mit Hängeregisterschublade wurde Gegengewicht zugegeben, um die Stabilität des Containers zu verbessern

Caissons avec tiroir DS équipés d'un contrepoids, afin d'assurer la stabilité de caissons

BUDGET STORAGES / SCHRANKSYSTEME / RENGEMENTS ECONOMIQUES

COUNTER TOP, FRONT
OBERPLATTE, FRONT
TOP, FRONT

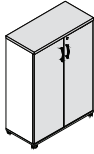

14 - BEECH
BUCHE
HETRE

34 - CHESTNUT
WENGE
WENGE

64 - COCOA
COCOA
CACAO

106 - LOWLAND NUT
NUSSBAUM
NOYER

31 - CANADIAN OAK
KANADISCHE EICHE
CHENE CANADIEN

39 - POLAR BIRCH
POLARBIERKE
BOULEAU CLAIR

67 - WHITE PASTEL
WEIß PASTELL
BLANC PASTEL

BODY
KORPUS
CORPS

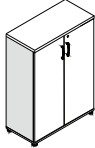



26 - ALUMINUM SATINATO
ALUMINIUM SATINATO
ALUMINIUM SATINE

67 - WHITE PASTEL
WEIß PASTELL
BLANC PASTEL



BUDGET STORAGES / SCHRANKSYSTEME / RENGEMENTS ECONOMIQUES

PRODUCT ILLUSTRATION PRODUKTANSICHT UND SKIZZE VUE DE PRODUIT	DIMENSIONS / ABMESSUNGEN / DIMENSIONS (mm)			INDEX / SYMBOL					ECO	REMARKS BEMERKUNGEN REMARQUES
	width/Breite/ largeur	depth/Tiefe/ profondeur	height/Höhe/ hauteur			kg	m ³	pcs	€	



STORAGES AND BOOKCASES 20H/ SCHRANKE UNO REGALE 20H/ ARMOIRES ET ETAGERES 1 TABLETTES

	800	385	777	K2104		25,6	0,071	3	2.841	
	800	385	777	K2504		18,1	0,044	2	2.006	

STORAGES HANGING UNITS 20H / ANSÄTZE 20H / REHAUSSE 1 TABLETTE

	800	385	750	K1104		25,6	0,071	3	2.841	
	800	385	750	K1504		18,1	0,044	2	2.006	

STORAGES AND BOOKCASES 30H/ SCHRÄNKE UND REGALE 30H/ ARMOIRES ET ETAGERES 2 TABLETTES

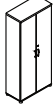
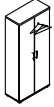
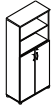

	800	385	1129	K3104		34,4	0,088	3	3.817	
	800	385	1129	K3404		31,3	0,089	3	3.471	
	800	385	1129	K3504		23,8	0,062	2	2.637	

STORAGES AND BOOKCASES 50H/ SCHRÄNKE UND REGALE 50H/ ARMOIRES ET ETAGERES 4 TABLETTES

	800	385	1833	K5104		34,4	0,088	3	6.231	
 1	800	385	1833	K5204		31,3	0,089	3	5.274	
	800	385	1833	K5304		23,8	0,062	2	5.458	

1 wardrobe with slide out hanger /
Garderobenschrank mit Ausschubstange /
vestiaire avec kit penderie



LEGEND/LEGENDE/LÉGENDE:

 - net weight/Nettogewicht/poids net  - volume/Volumen/le volume  - number of packages/Anzahl der Pakete/nombre de colis

BUDGET STORAGES / SCHRANKSYSTEME / RENGEMENTS ECONOMIQUES

PRODUCT ILLUSTRATION PRODUKTANSICHT UND SKIZZE VUE DE PRODUIT	DIMENSIONS / ABMESSUNGEN / DIMENSIONS (mm)			INDEX / SYMBOL					ECO	REMARKS BEMERKUNGEN REMARQUES
	width/Breite/ largeur	depth/Tiefe/ profondeur	height/Höhe/ hauteur			kg	m ³	pcs	€	

STORAGE 5 OH / SCHRÄNKE UND REGALE 5 OH / ARMOIRES ET ETAGERES 4 tablettes

	800	385	1833	K5404		25,6	0,071	3	5,112	
	800	385	1833	K5504		18,1	0,044	2	4,277	





TAMBOUR STORAGE / ROLLADENSCHRANK / ARMOIRES A RIDEAUX

	1200	385	1129	K3Z06		61,3	0,6	1	6,804	
---	------	-----	------	--------------	--	------	-----	---	-------	--



CABINET FOR PHOTOCOPIER / KOPIERER-SCHRANK / DESSERTÉ À CASES POUR PHOTOCOPIEURS

	710	600	600	S85		31,3	0,065	1	3,473	
--	-----	-----	-----	------------	--	------	-------	---	-------	--

PEDESTALS / CONTAINER MIT PLATTENSCHUBLADEN / CAISSONS A TIROIRS

	416	600	590	KKT11		30,9	0,191	1	3,028	
	400	600	590	KKT12		27,6	0,191	1	2,805	
	400	600	590	KKT13		24,5	0,144	1	2,720	
	400	600	720/ 740	KKT64		34,4	0,213	1	3,818	
	400	800	720/ 740	KKT74		39,9	0,282	1	4,432	

LEGEND/LEGENDE/LÉGENDE:

 - net weight/Nettogewicht/poids net  - volume/Volumen/le volume  - number of packages/Anzahl der Pakete/nombre de colis